



### SUHP-36-6 & ARHP-24-4

Hand polished stainless steel finish  
 SUHP-36-6 shown with  
 Heavy Duty Stand (optional)

#### STANDARD FEATURES

- Heavy duty stainless steel front and sides.
- Heavy gauge steel chassis.
- Heavy duty 12" (305) X 12" (305) cast iron top grates, easily removable.
- Compact design for countertop use.
- Two-piece lift off burners, rated at 32,000 BTU/hr. each.
- Polished glossy black knobs.
- Individual stainless steel standing pilots for instant ignition of each burner.
- Manual gas control valve for each burner.
- Full width removable crumb tray for easy cleaning.
- Die-cast, black control knobs.
- Easy cleaning removable lift off cast iron burner heads.
- Optional 4" legs or heavy duty equipment stands available.
- Removable drip pan for easy cleaning.
- One year limited warranty, parts and labor.

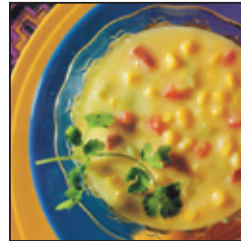

American Range ARHP series is designed with safety, durability and convenience in mind, with heavy duty construction and uniquely designed top grates. These products will provide years of trouble-free performance in the most demanding service operation. Uncompromising quality, performance and service at an affordable price.

SCALE: NOT TO SCALE

**HEAVY DUTY HOT PLATES**

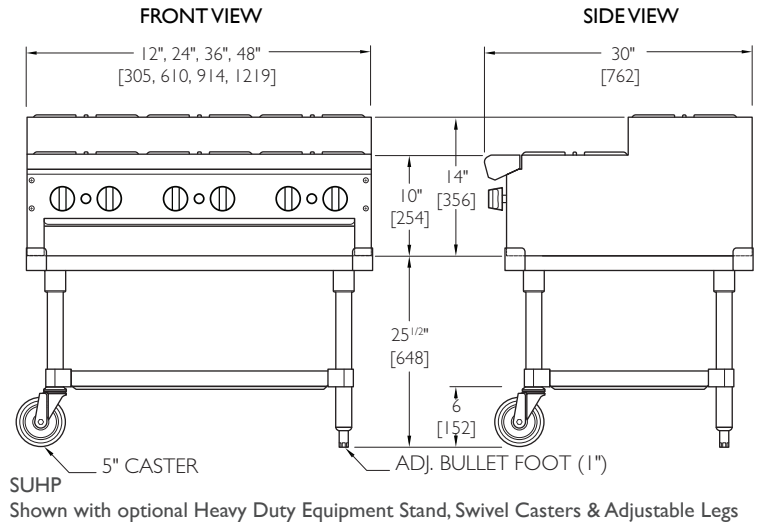
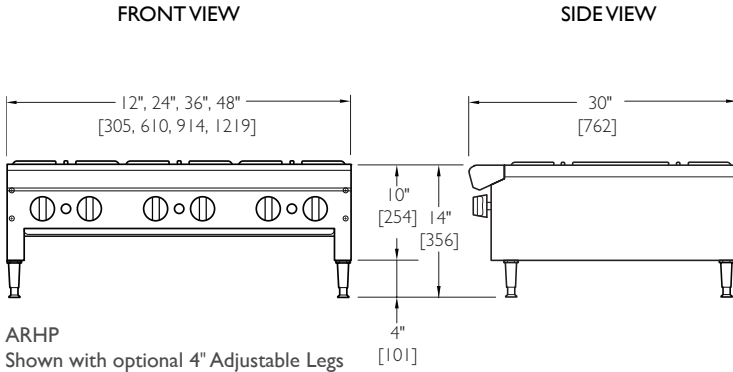

**HEAVY DUTY THERMOSTATIC GRIDDLES: HIGHLY POLISHED 3/4" THICK HOT PLATES**

Model	Width	Depth	Height	Burners	Total BTU	(KW)	Shipping Weight	Lbs.	(Kg.)	MODEL	Lbs.	(kg)
ARHP-12-1	12"	18"	10"	1	32,000	(9)		51	(23)	ESS-12	35	(15)
ARHP-12-2	12"	30"	10"	2	64,000	(18)		85	(38)	ESS-24	47	(21)
ARHP-24-2	24"	18"	10"	2	64,000	(18)		85	(38)	ESS-24	47	(21)
ARHP-24-4	24"	30"	10"	4	128,000	(37)		140	(63)	ESS-36	54	(25)
ARHP-36-3	36"	18"	10"	3	96,000	(28)		115	(52)	ESS-36	54	(25)
ARHP-36-6	36"	30"	10"	6	192,000	(56)		210	(95)	ESS-36	54	(25)
ARHP-48-4	48"	18"	10"	4	128,000	(37)		140	(63)	ESS-48	72	(33)
ARHP-48-8	48"	30"	10"	8	256,000	(75)		270	(122)	ESS-48	72	(33)
ARHP-60-10	60"	30"	10"	10	320,000	(93)		325	(147)	ESS-60	99	(45)

• Casters for stands (set of 4) A35104  
• Casters for stands (set of 6) A35105

**HEAVY DUTY THERMOSTATIC GRIDDLES: HIGHLY POLISHED 3/4" THICK HOT PLATES - STEP UP**

Model	Width	Depth	Height	Burners	Total BTU	(KW)	Shipping Weight	Lbs.	(Kg.)	MODEL	Lbs.	(kg)
SUHP-12-2	12"	30"	14"	2	64,000	(18)		185	61	ESS-12	35	(15)
SUHP-24-4	24"	30"	14"	4	128,000	(37)		210	95	ESS-24	47	(21)
SUHP-36-6	36"	30"	14"	6	192,000	(56)		355	161	ESS-36	54	(25)
SUHP-48-8	48"	30"	14"	8	256,000	(75)		380	172	ESS-48	72	(33)

• Casters for stands (set of 4) A35104  
• Casters for stands (set of 6) A35105

**STANDARD FEATURES**

- Heavy duty stainless steel front and sides.
- Heavy gauge steel chassis.
- Heavy duty 12" (305) X 12" (305) cast iron top grates, easily removable.
- Compact design for countertop use.
- Two-piece lift off burners, rated at 32,000 BTU/hr. each, highest in the industry.
- Individual stainless steel standing pilots for instant ignition of each burner.
- Manual gas control valve for each burner.
- Full width removable crumb tray for easy cleaning.
- Die-cast, black control knobs.
- Easy cleaning removable lift off cast iron burner heads.
- One year limited warranty, parts and labor.

**OPTIONAL FEATURES**

- Sauté burner head.
- Wok burner head.
- Stainless steel wok ring.
- Heavy duty equipment stand.
- Swivel casters
- 4" adjustable legs.

GAS SUPPLY: 3/4" NPT Gas inlet 7" to 9" W.C., Manifold pressure is 5.0" W.C. for natural gas, or 11" - 12" Manifold pressure is 10.0" W.C. for propane gas. Specify type of gas and altitude if over 2000 feet.

CLEARANCES: For use only on non-combustible floors. Legs or casters are required, or 2" (51mm) overhang is required when curb mounted. Clearance from non-combustible walls is 0". Non-combustible locations only.

\*The American Range Company continually improves its products and reserves the right to change materials, specifications and dimensions without notice.

This unit is manufactured for commercial use only.

**ARHP MODELS**

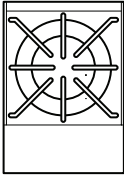

ARHP-12-1

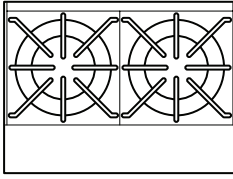

ARHP-24-2

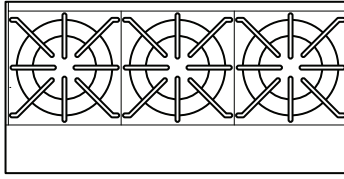

ARHP-36-3

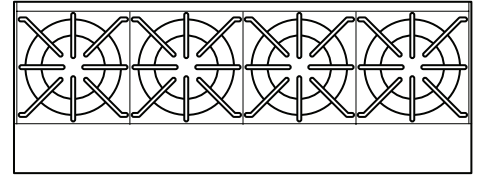

ARHP-48-4

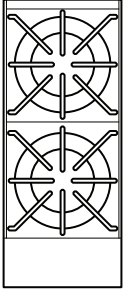

ARHP-12-2

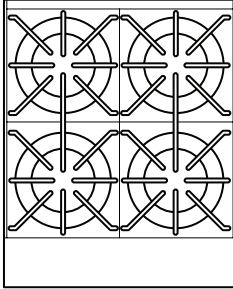

ARHP-24-4

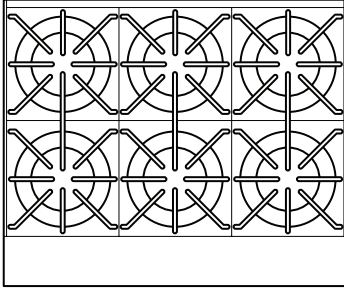

ARHP-36-6

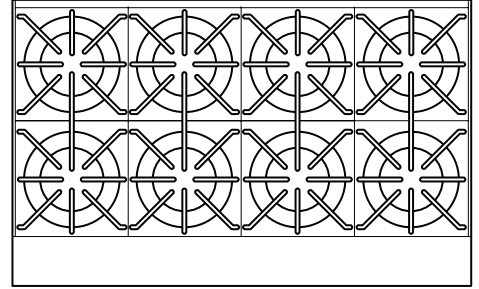

ARHP-48-8

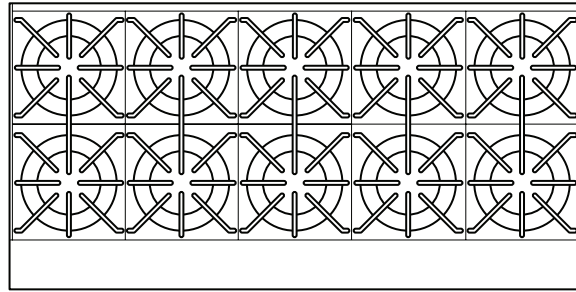

ARHP-60-10

SCALE: NOT TO SCALE

**SUHP MODELS**

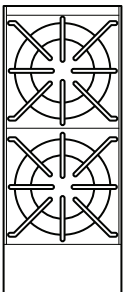

SUHP-12-2

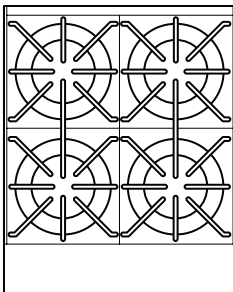

SUHP-24-4

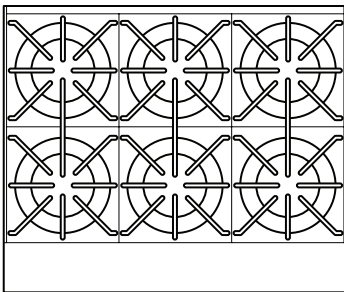

SUHP-36-6

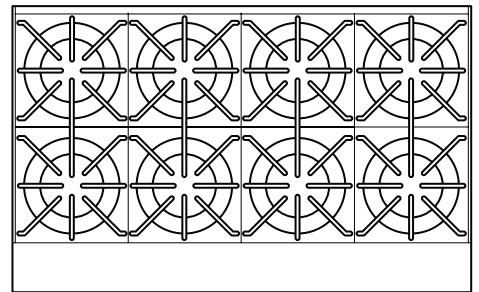

SUHP-48-8

SCALE: NOT TO SCALE

