

# BUNN®

**DUAL® TF DBC®**  
**W/SMART FUNNEL®**

S/N DUAL068000 & UP

**SINGLE® TF DBC®**  
**W/SMART FUNNEL®**

S/N SNG0033000 & UP

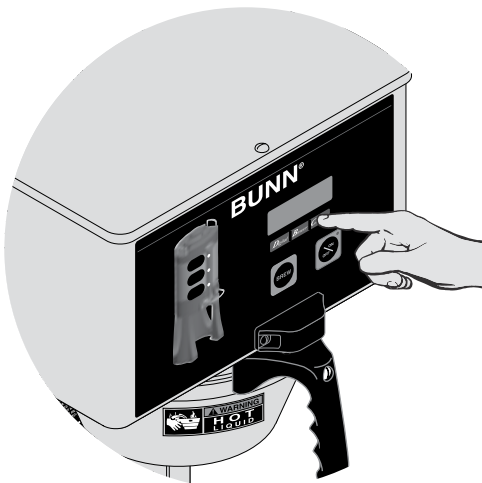
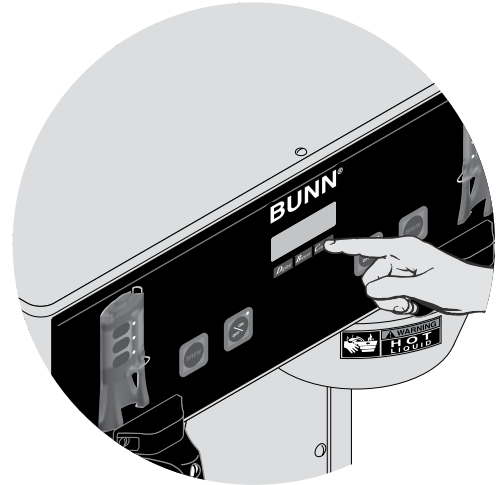

## PROGRAMMING MANUAL

**BUNN-O-MATIC CORPORATION**

POST OFFICE BOX 3227

SPRINGFIELD, ILLINOIS 62708-3227

PHONE: (217) 529-6601 FAX: (217) 529-6644



## **BUNN-O-MATIC COMMERCIAL PRODUCT WARRANTY**

Bunn-O-Matic Corp. ("BUNN") warrants equipment manufactured by it as follows:

- 1) Airpots, thermal carafes, decanters, GPR servers, iced tea/coffee dispensers, MCP/MCA pod brewers thermal servers and ThermoFresh servers (mechanical and digital)- 1 year parts and 1 year labor.
- 2) All other equipment - 2 years parts and 1 year labor plus added warranties as specified below:
  - a) Electronic circuit and/or control boards - parts and labor for 3 years.
  - b) Compressors on refrigeration equipment - 5 years parts and 1 year labor.
  - c) Grinding burrs on coffee grinding equipment to grind coffee to meet original factory screen sieve analysis - parts and labor for 4 years or 40,000 pounds of coffee, whichever comes first.

These warranty periods run from the date of installation BUNN warrants that the equipment manufactured by it will be commercially free of defects in material and workmanship existing at the time of manufacture and appearing within the applicable warranty period. This warranty does not apply to any equipment, component or part that was not manufactured by BUNN or that, in BUNN's judgment, has been affected by misuse, neglect, alteration, improper installation or operation, improper maintenance or repair, non periodic cleaning and descaling, equipment failures related to poor water quality, damage or casualty. In addition, the warranty does not apply to replacement of items subject to normal use including but not limited to user replaceable parts such as seals and gaskets. This warranty is conditioned on the Buyer 1) giving BUNN prompt notice of any claim to be made under this warranty by telephone at (217) 529-6601 or by writing to Post Office Box 3227, Springfield, Illinois 62708-3227; 2) if requested by BUNN, shipping the defective equipment prepaid to an authorized BUNN service location; and 3) receiving prior authorization from BUNN that the defective equipment is under warranty.

**THE FOREGOING WARRANTY IS EXCLUSIVE AND IS IN LIEU OF ANY OTHER WARRANTY, WRITTEN OR ORAL, EXPRESS OR IMPLIED, INCLUDING, BUT NOT LIMITED TO, ANY IMPLIED WARRANTY OF EITHER MERCHANTABILITY OR FITNESS FOR A PARTICULAR PURPOSE.** The agents, dealers or employees of BUNN are not authorized to make modifications to this warranty or to make additional warranties that are binding on BUNN. Accordingly, statements by such individuals, whether oral or written, do not constitute warranties and should not be relied upon.

If BUNN determines in its sole discretion that the equipment does not conform to the warranty, BUNN, at its exclusive option while the equipment is under warranty, shall either 1) provide at no charge replacement parts and/or labor (during the applicable parts and labor warranty periods specified above) to repair the defective components, provided that this repair is done by a BUNN Authorized Service Representative; or 2) shall replace the equipment or refund the purchase price for the equipment.

**THE BUYER'S REMEDY AGAINST BUNN FOR THE BREACH OF ANY OBLIGATION ARISING OUT OF THE SALE OF THIS EQUIPMENT, WHETHER DERIVED FROM WARRANTY OR OTHERWISE, SHALL BE LIMITED, AT BUNN'S SOLE OPTION AS SPECIFIED HEREIN, TO REPAIR, REPLACEMENT OR REFUND.**

In no event shall BUNN be liable for any other damage or loss, including, but not limited to, lost profits, lost sales, loss of use of equipment, claims of Buyer's customers, cost of capital, cost of down time, cost of substitute equipment, facilities or services, or any other special, incidental or consequential damages.

392, AutoPOD, AXIOM, BrewLOGIC, BrewMETER, Brew Better Not Bitter, BrewWISE, BrewWIZARD, BUNN Espresso, BUNN Family Gourmet, BUNN Gourmet, BUNN Pour-O-Matic, BUNN, BUNN with the stylized red line, BUNNlink, Bunn-OMatic, Bunn-O-Matic, BUNNserve, BUNNSERVE with the stylized wrench design, Cool Froth, DBC, Dr. Brew stylized Dr. design, Dual, Easy Pour, EasyClear, EasyGard, FlavorGard, Gourmet Ice, Gourmet Juice, High Intensity, iMIX, Infusion Series, Intellisteam, My Café, Phase Brew, PowerLogic, Quality Beverage Equipment Worldwide, Respect Earth, Respect Earth with the stylized leaf and coffee cherry design, Safety-Fresh, savemycoffee.com, Scale-Pro, Silver Series, Single, Smart Funnel, Smart Hopper, SmartWAVE, Soft Heat, SplashGard, The Mark of Quality in Beverage Equipment Worldwide, ThermoFresh, Titan, trifecta, Velocity Brew, A Partner You Can Count On, Air Brew, Air Infusion, Beverage Bar Creator, Beverage Profit Calculator, Brew better, not bitter., BUNNSource, Coffee At Its Best, Cyclonic Heating System, Daypart, Digital Brewer Control, Nothing Brews Like a BUNN, Pouring Profits, Signature Series, Tea At Its Best, The Horizontal Red Line, Ultra are either trademarks or registered trademarks of Bunn-O-Matic Corporation.

## INTRODUCTION

The brewer incorporates a wireless interface system that allows the DBC Grinder to load certain information into the "programming chip" located inside the handle of the funnel. This information includes what flavor of coffee is being ground and what batch size will be brewed (small, medium, or large). Once the correct flavor name and amount of coffee is ground, the funnel is loaded into the brewer. The information from the funnel handle is then transferred into the brewer. The brewer then takes this information and dispenses the amount of water preset in the brewer for that particular flavor of coffee and batch size. The brewer can also be programmed to adjust different functions of the brewing process, such as brew temperature, brew volumes, bypass percentages, pulse brew, etc. This allows the operator to program a certain "recipe" for each coffee flavor to be brewed.

## TABLE OF CONTENTS

Glossary.....	4
<b>PROGRAMMING</b> .....	5
Programming Switches.....	5
Programming the Brewer.....	6
PROGRAM FUNCTIONS (LEVEL 1) <b>Brew Lockout</b> .....	6
PROGRAM FUNCTIONS (LEVEL 2) .....	7
PROGRAM FUNCTIONS (FLOW).....	8
<b>Set Units (Setting units of measure)</b> .....	11
<b>Enable Energy Saver</b> .....	12
<b>Set New Recipe (using a Smart Funnel and G92T DBC or MHG Grinder)</b> .....	13
Set Brew Volumes.....	13
Set By-Pass Percentages .....	14
Set Pulse Brew and Drip Times.....	14
<b>Set New Recipe (using a Recipe Card)</b> .....	15
<b>Set New Recipe (no Smart Funnel nor G9-2T DBC Grinder)</b> .....	16
<b>Review Recipes/Modify Recipes/Set up No Name Coffee</b> .....	17
Set Brew Volumes.....	18
Set Bypass Percentages.....	19
Set Pulse Brew.....	20
Easy Method .....	22
Manual Method .....	23
Set Drip Times .....	24
<b>Assign Recipes</b> .....	25
<b>Copy Settings</b> .....	25
<b>Enable Ads</b> .....	26
<b>Set Temp</b> (Brewing Temperature) .....	26
<b>Set Ready</b> (Ready Temperature).....	27
<b>Refill</b> (Adjust Sensitivity) .....	27
<b>Spray Oz/M</b> (Read sprayhead flow rate) .....	28
<b>Bypass Oz/M</b> (Read bypass flow rate) .....	29
<b>Calibrate Flow</b> .....	30
Calibrate Sprayhead Flow.....	30
Calibrate Bypass Flow .....	31
<b>Brew Counters</b> (View/Reset).....	32
<b>Funnel Detect</b> .....	33
<b>Service Tools</b> .....	33
Test Outputs (Components) .....	33
Test Switches .....	34
Test Frequency .....	34
<b>Factory Defaults</b> (Reset) .....	36

## GLOSSARY

- AD CARD:** An assembly consisting of computer chips and an instruction label. Used for loading advertising messages into the brewer.
- BREW LOCKOUT:** The inability to initiate a brew if the water temperature is less than the ready temperature programmed into the brewer.
- BYPASS:** The process of diverting a portion of the brew water to the outside of the paper filter so that it does not pass through the coffee grounds. This process is sometimes used to optimize the flavor of the finished brew.
- CHIP:** A computer chip containing either recipes for specific coffee flavors or advertising messages which are read by the sensing coils on the brewer. One chip is embedded in each Smart Funnel® handle to carry the coffee flavor name and batch size ground from the grinder to the brewer.
- DRIP TIME:** The length of time from when the water spray over the grounds ends, to the time that no water drips from the funnel tip.
- FACTORY DEFAULTS:** The factory preset brew settings that were installed into the brewer's memory.
- FIRST ON-TIME:** During a pulse brew, this is the time set for the initial flow of water over the grounds.
- FUNNEL DETECT:** Sets the inability to initiate a brew cycle if the funnel is not properly inserted into the funnel rails.
- FUNNEL SENSING COIL:** A sensor on the front hood of the brewer, which reads what name and batch size of coffee was ground into the funnel and allows for the brewer to automatically set itself to what is read from the funnel handle.
- LAST ON-TIME:** During a pulse brew, this is the time set for the second on-time, and each alternating on-time for the remainder of the brew cycle.
- MAIN SCREEN:** The term used to describe the screen that is displayed when the brewer is not in use. This screen is also displayed after exiting the programming mode.
- NO-NAME COFFEE:** The term for the recipe used by the brewer when there is no coffee name stored in the funnel. The brewer can contain separate No-Name recipes for the left and right brewing positions.
- OFF-TIME:** During a pulse brew or preinfusion, this is the time set for the length of time that the water is not spraying over the grounds.
- PREINFUSION:** The process of beginning a brewing cycle with an initial spray of water onto the grounds followed by a pause in the spray. After the programmed pause, the spray continues without interruption until the end of the brewing cycle.
- PULSE BREW:** The process which allows the brew water to start, then stop, repeatedly, over the grounds in order to derive the best flavor from the coffee. Pulse brew is also used in some instances to prevent a funnel overflow.
- RECIPE:** Set of brewing parameters stored in the brewer. The parameters are unique for each coffee name and include brew ounces, pulse brew, percent bypass, preinfusion and drip time.
- RECIPE CARD:** An assembly consisting of a computer chip and an instruction label. Used for loading a recipe into the brewer and the companion DBC Grinder.

# PROGRAMMING

Using the menu-driven display on the front of the brewer, the operator has the ability to alter or modify various brewing parameters such as brew temperatures, brew volumes, bypass percentages, etc. This allows for the precise brewing of various flavors of coffee.

Programming of the brewer is achieved by entering a certain function. Then, by the use of hidden programming switches, the operator can customize the brewing process to their specifications.

## PROGRAMMING SWITCHES

To access the programming mode, and to scroll through the different function screens, hidden programming switches are used. There are five of these switches that will be used for the setup of the brewer.

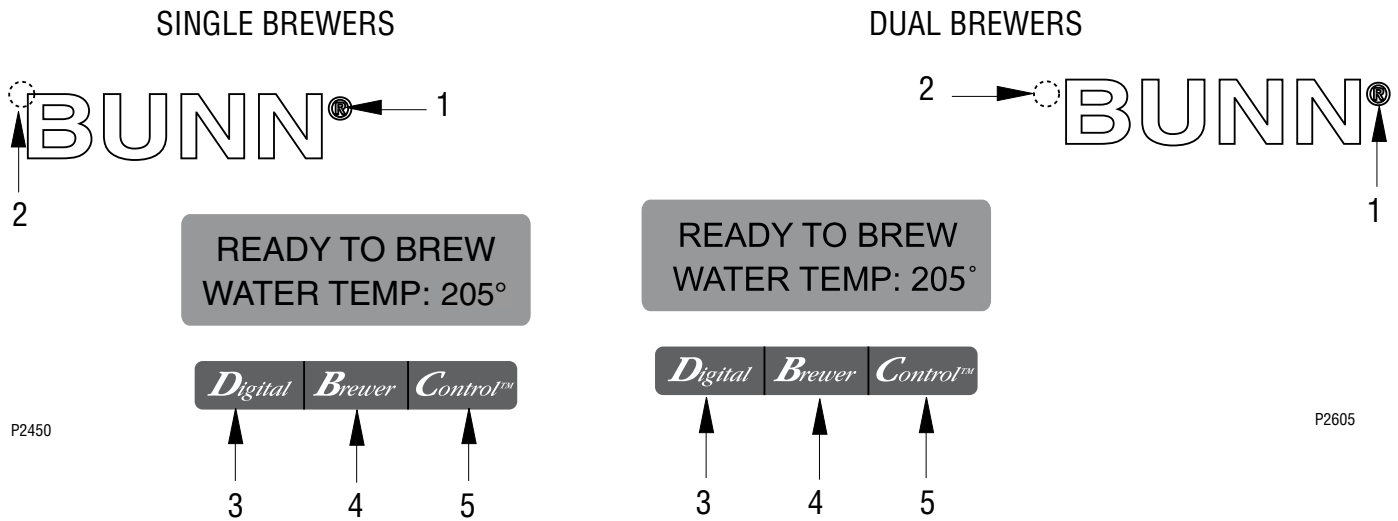

1. **® symbol** (upper right of the BUNN logo)  
This is used to access the programming mode and is also used to scroll forward through the function list.
2. **Upper left corner** of the "B" in the BUNN logo  
This is used to scroll backwards through the function list.
3. **"Digital"** (lower left under the display)  
This is used to select options that appear on the display during programming.
4. **"Brewer"** (center under the display)  
This is used to select options that appear on the display during programming.
5. **"Control"** (lower right under the display)  
This is used to select options that appear on the display during programming.

## PROGRAMMING THE BREWER

The programming of the brewer is divided into two levels. There is one function in Level 1. All other functions are accessed in Level 2.

The following function screens are in order of appearance. Each screen will have instructions on how to access, and the procedures to program the various functions of the brewer.

### IMPORTANT PROGRAMMING NOTES - READ CAREFULLY -

To exit the programming mode at any time, press and release the ON/OFF switch (either on DUAL brewers) located on the front switch panel. The display will return to the **MAIN SCREEN**.

If none of the five programming switches are pressed within one minute during the setup of the brewer, the programming of the function screen that is being set will be exited and the display will return to the **MAIN SCREEN**.

Always remember to place a container and funnel under the sprayhead when operating the brewer during the set-up of **PULSE BREW**, **CALIBRATE FLOW** and testing the brew and bypass valves in **SERVICE TOOLS/TEST OUTPUTS**.

#### MAIN SCREEN



READY TO BREW  
WATER TEMP: 205°



*Digital Brewer Control™*

This screen will be shown when the brewer is ready for use. The screen displays the water temperature in the tank. When the water in the tank reaches the correct set temperature, the display will change from **HEATING** to **READY TO BREW**.

#### PROGRAMMING LOCKOUT SWITCH (mounted on main control board)

This switch can be set to prevent access to the programming levels of the brewer. Once all the correct brew settings are programmed, the operator can set the switch to the "DISABLE" position to prohibit anyone from changing the settings.

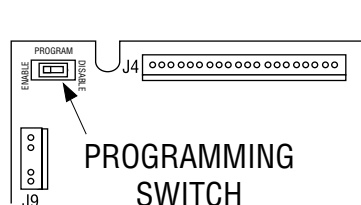

P2424

#### PROGRAM FUNCTIONS - LEVEL 1

##### BREW LOCKOUT

This function allows the operator to prevent or allow brewing if the water temperature is less than the set **READY** temperature.

To access this function screen press and hold the **®** symbol. Release the **®** when the display reads:



BREW LOCKOUT?  
NO DONE YES



*Digital Brewer Control™*

Press here for **NO**      Press here for **DONE**      Press here for **YES**

The **YES** or **NO** should be flashing. Select **YES** to prevent brewing if the water temperature is below the set **READY** temperature. Select **NO** to permit brewing at any water temperature.

When finished, press and release **DONE**. This will exit this function screen and return to the **MAIN SCREEN** on the display.

## PROGRAMMING THE BREWER (cont.)

### PROGRAM FUNCTIONS - LEVEL 2

There are three methods of programming the various brewing parameters of the SINGLE TF and DUAL TF with Smart Funnel Brewers.

#### METHOD 1:

##### Using a Smart Funnel and a G9-2T DBC or MHG Grinder:

Certain coffee **NAMES** are stored in the G9-2T DBC or MHG's memory. When a particular name of coffee is ground into the Smart Funnel, that name and the batch size selected are transferred from the grinder to the programming **chip** located in the funnel's handle. The funnel is then inserted into the brewer's funnel rails (left side on DUAL brewers). The sensor coil on the brewer reads the information contained in the handle. This then allows the operator to set the **BREW VOLUMES, BYPASS PERCENTAGES, PULSE BREW TIMES, PREINFUSION TIMES** and **DRIP-OUT TIMES** for that particular coffee **NAME**. Each coffee **NAME** can be set individually to provide optimum brewing quality.

#### RECIPES

This diagram allows for the creating, modifying, or viewing of recipes in the brewer.

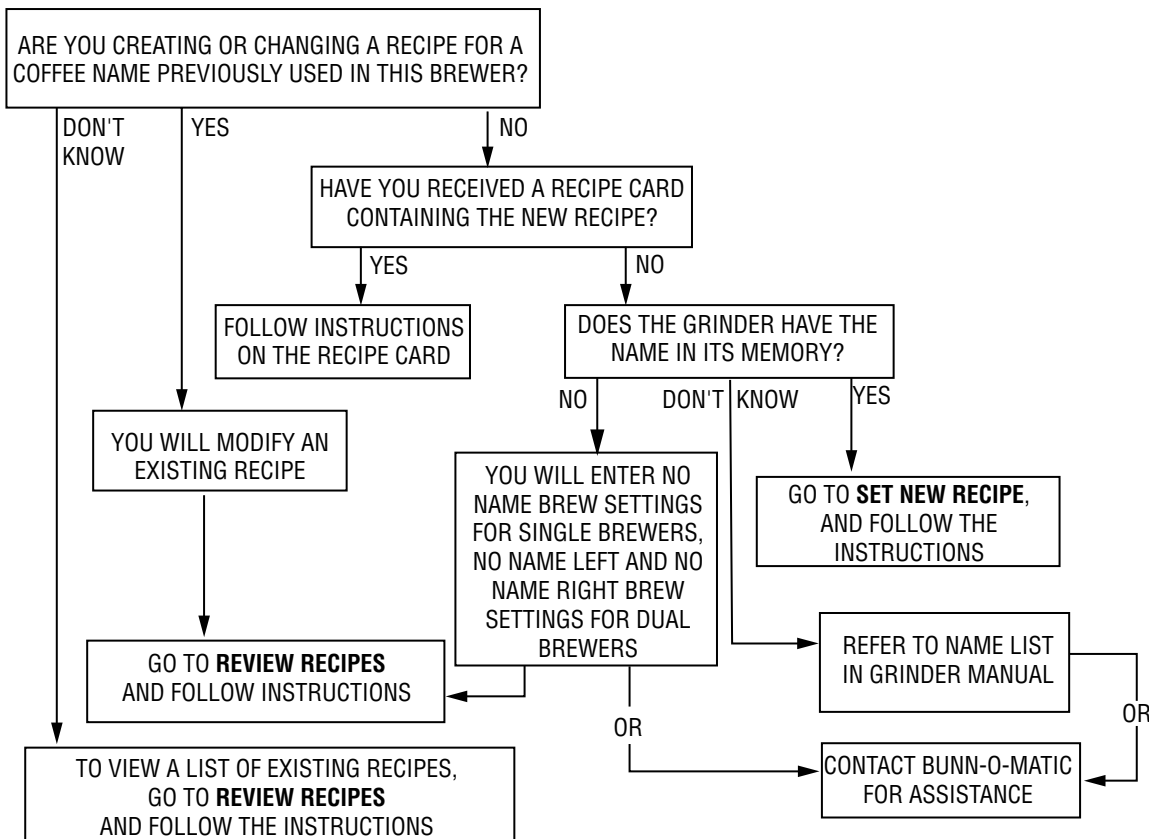

#### METHOD 2:

##### Using a **RECIPE CARD** to enter all of the brew settings at one time:

If using a coffee name not in the grinder's memory, the customer can obtain a **RECIPE CARD** from the factory with all the information needed to set up that particular coffee name. This includes the **COFFEE NAME, BREW VOLUMES, BYPASS PERCENTAGES, PULSE BREW TIMES, PREINFUSION TIMES, and DRIP-OUT TIMES**.

#### METHOD 3:

##### Not using a Smart Funnel and/or a G9-2T DBC or MHG Grinder:

This allows the operator to enter **ONE** set of brewing parameters (for each side on DUAL brewers), in the event a Smart Funnel and/or a G9-2T DBC or MHG is not used with the SINGLE TF or DUAL TF Brewer. This is referred to as a **NO NAME** coffee flavor. If the brewer does not read the information in the funnel's handle, it automatically selects the **NO NAME** brewing parameters set up prior to brewing. This includes **BREW VOLUMES, BYPASS PERCENTAGES, PULSE BREW TIMES, PREINFUSION TIMES** and **DRIP-OUT TIMES** for the three batch sizes.





# PROGRAMMING THE BREWER (cont.)

## PROGRAM FLOW DIAGRAM (Cont.)

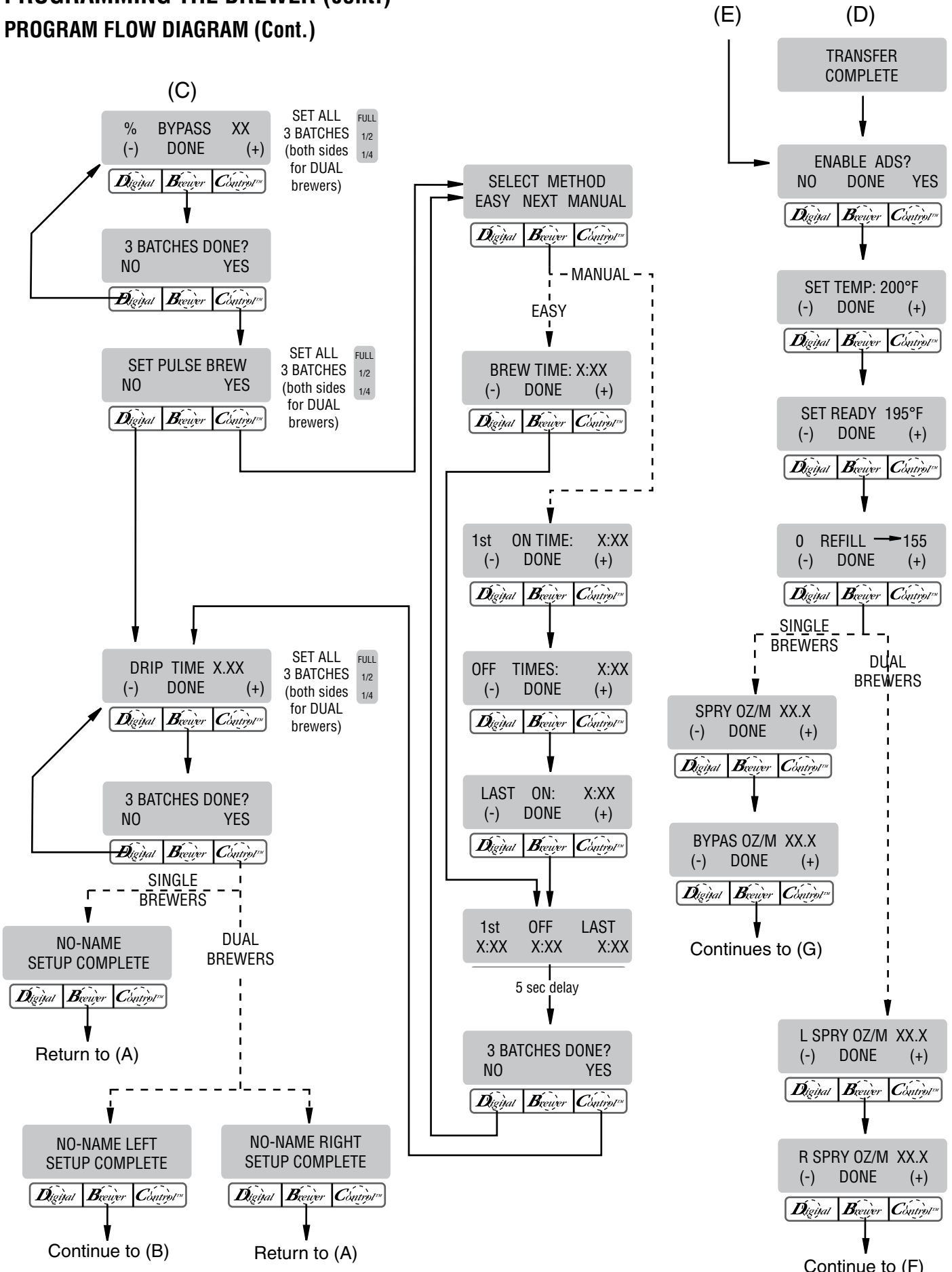

# PROGRAMMING THE BREWER (cont.)

## PROGRAM FLOW DIAGRAM (Cont.)

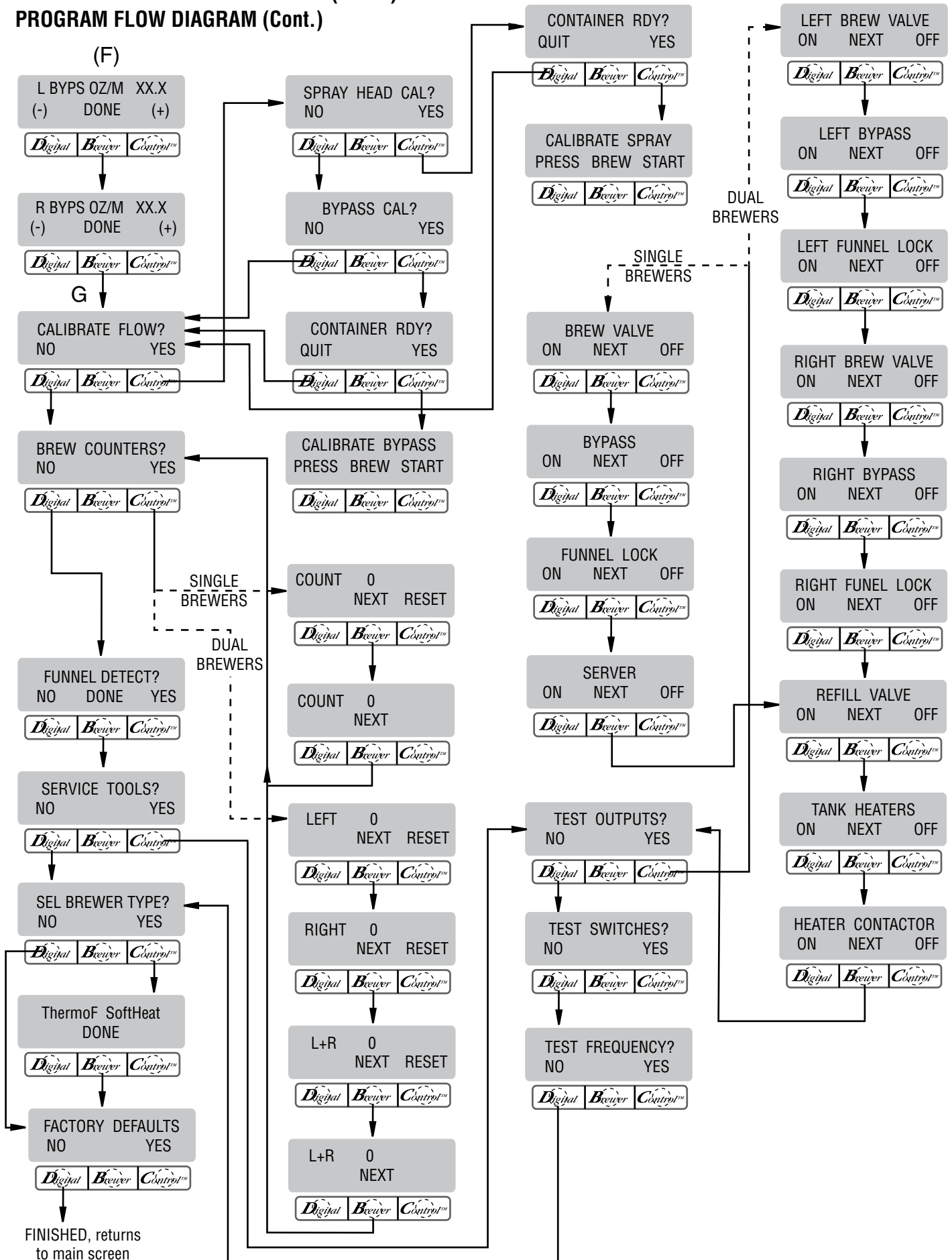

## PROGRAMMING THE BREWER (cont.)

### UNITS (SETTING UNITS OF MEASURE)

This function allows the units of measure to be set in English or Metric readings for all screens. The program is defaulted to English.

**WARNING:** Changing the unit of measure will erase all coffee recipes stored in memory. All preinfusion, pulse times, etc will also be erased. If using this option after information has been stored, it is important to have this information stored elsewhere so that the machine can be reprogrammed.

#### Procedure for modifying units of measure:

1. Press and hold upper right hidden switch until the display reads **UNITS**. Release switch. Press and release **METRIC** or **ENG** to make a selection.
2. Press **DONE** to proceed. The display should now read **CHANGING UNITS!! WILL ERASE!! ... ALL PREVIOUSLY STORED RECIPES AND ALL SETUP INFO WILL BE LOST ... ARE YOU SURE?**
3. Press **YES** to begin the change. While the change is in process, the display will read **RESTORING DEFAULTS** and a count down will begin.
4. When the count down reaches 0 the display will read **SET NEW RECIPE?**. The units have been reset.
5. Press and release the ON/OFF switch (either on DUAL brewers) located on the front switch panel to exit the **UNITS** function and return to the **MAIN SCREEN**.

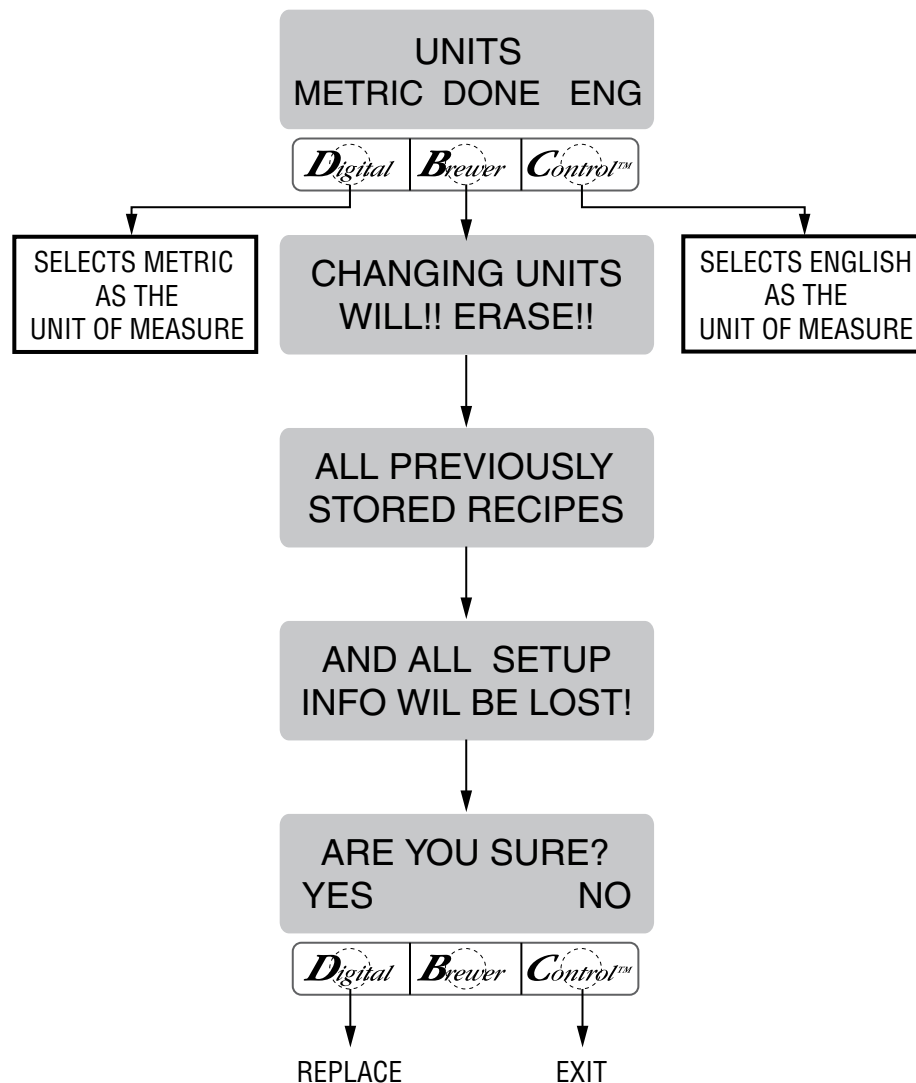

P3260

## PROGRAMMING THE BREWER (cont.)

### ENABLE ENERGYSAVR

This function allows the operator to enable the ENERGY SAVINGS mode function and set the idle time. Once the set idle time has expired, the operator can choose to have the heaters either turn off, or reduce the tank holding temp to 140° F (60° C).

#### Procedure to enable energy savings mode:

##### Range: 0.5 to 24.0 hrs

If enabled, default setting is 140° F (60° C) tank temperature after 4.0 hrs. idle time.

1. Press and hold the right hidden switch until the display reads **SET LANGUAGE**. Press the right hidden switch until the display reads **Enabl EnergySavr**. The **YES** or **NO** will be flashing to indicate the current selection.
2. Press and release **NO** to disable this function, or:
3. Press and release **YES** to enable this function (the heaters will either turn off or the tank will hold at 140° F).
4. When finished, press and release **DONE** to save the new setting and advance to the next function screen.
5. If **NO** was selected, the display should now read **SET NEW RECIPE ?**. To exit programming and return to the **MAIN SCREEN**, press and release the ON/OFF switch (either for DUAL Brewers).
6. If **YES** was selected, the display should now read **X.X HRS -> IDLE**. This screen allows the operator to set the amount of time the brewer is not in use before nap mode engages. Using **(-)** and **(+)**, adjust the idle time. When finished, press and release **DONE**.
7. The display should now read **AFTER IDLE TIME?** Once the set idle time has expired, the heaters can either be shut off or held at a lower temperature of 140° F.
8. To have the machine shut off after the set idle time, press and release **OFF** and then **DONE** to save the settings. The display should read **MACHINE OFF AFTER X.X HRS**, and then **SET NEW RECIPE ?**.
9. To have the heaters hold at the lower 140° F temperature, press and release **140°** and then **DONE** to save the settings. The display should read **MACHINE AT 140° AFTER X.X HRS**, and then **SET NEW RECIPE ?**.

10. Once the idle time has expired, the display will read either **ENERGY SAVER...NO TEMPERATURE** or **ENERGY SAVER...REDUCED TEMPERATURE**, depending on the settings. This screen will alternate with **PRESS ANY SWITCH TO RE-HEAT**.

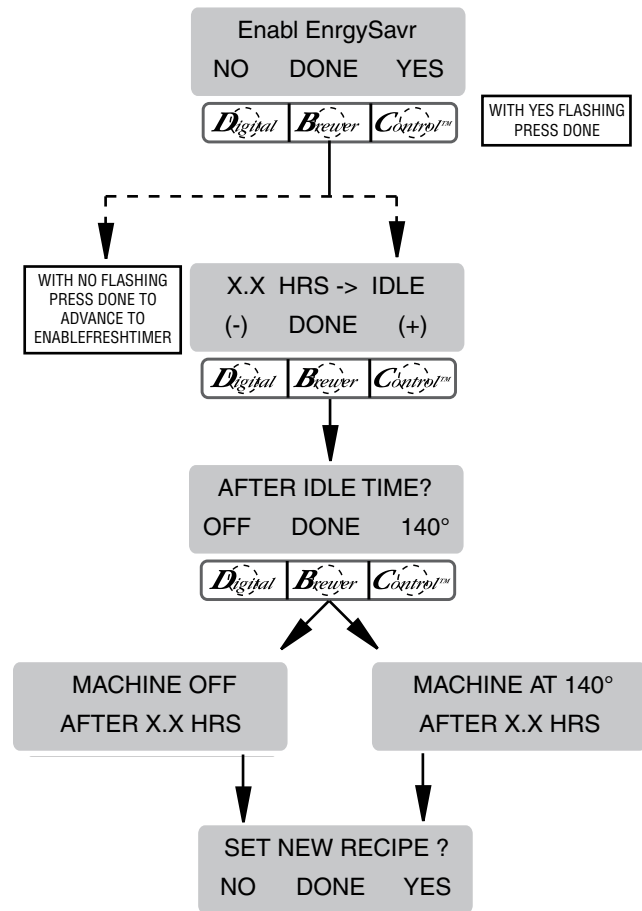

## PROGRAMMING THE BREWER (cont.)

### SET NEW RECIPE

Using a Smart Funnel and a G9-2T DBC or MHG Grinder:

This function allows operator to set **BREW VOLUMES, BYPASS PERCENTAGES, PULSE BREW TIMES** and **DRIP-OUT TIMES** for each coffee name preset in the grinder's memory.

Certain coffee **NAMES** are stored in the grinder's memory. When a particular name of coffee is ground into the Smart Funnel, that name and the batch size selected are transferred from the grinder to the programming **chip** located in the funnel handle. The funnel is then inserted into the brewer's left side funnel rails. The sensor coil on the brewer reads the information contained in the handle. The name of the coffee flavor will then appear on the display. This then allows the operator to set **BREW VOLUMES, BYPASS PERCENTAGES, PULSE BREW TIMES** and **DRIP-OUT TIMES** for that particular coffee **NAME**. It also allows the operator to set other brewing parameters, such as **BREW TEMPERATURE, READY TEMPERATURE, BREW LOCKOUTS**, etc. Each coffee **NAME** can be set individually to provide optimum brewing quality.

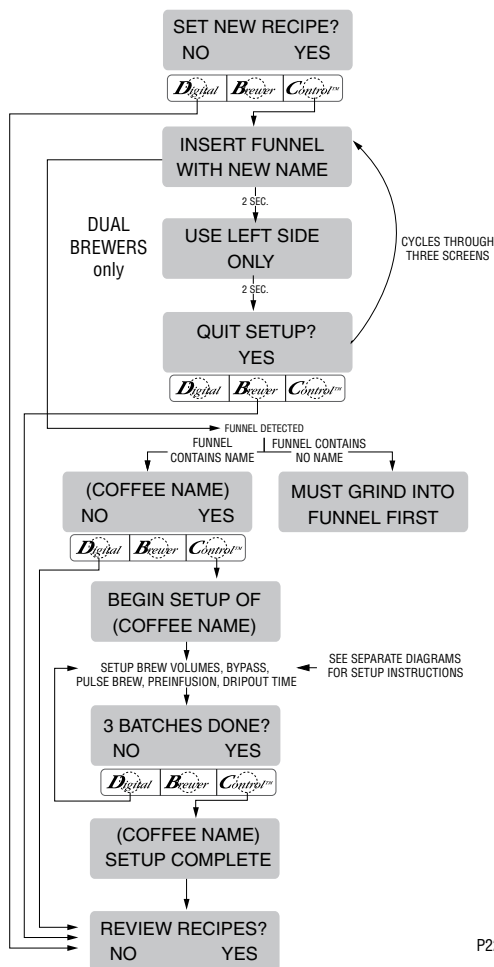

P2299-1

### Procedure for Setting the Recipe:

**NOTE:** Before beginning setup, place a server beneath the brew funnel (left side on DUAL brewers).

1. Insert the funnel into the grinder and select a batch size to grind. It is not necessary to have coffee beans in the hopper(s) in order to program the brewer. The coffee name is pre-selected and stored in the grinder's memory (for side being ground on DUAL brewers).
2. Press the GRIND switch. When the grinder stops grinding, remove the funnel.
3. On the brewer, press and hold the (®) switch until the display reads **UNITS**. Release the switch, then press switch again until display reads **SET NEW RECIPE**.
4. Press and release **YES**. The display should read **INSERT FUNNEL WITH NEW NAME**, then **USE LEFT SIDE ONLY** on DUAL brewers only, and finally, **QUIT SETUP?** These displays will repeatedly cycle.
5. Insert the funnel into the rails of the brewer (left side on DUAL brewers). The display should read the **NAME** of the coffee that was ground into the funnel, along with a **NO** and **YES**. If the **NAME** on the display is correct, press **YES**.
6. If, for some reason, the name of the coffee from the grinder did not load properly into the funnel, or if a grind has not yet been done, the display will read **MUST GRIND INTO FUNNEL FIRST**. It will be necessary to grind another batch following steps 1 and 2.
7. If the grind is acknowledged by the brewer, the display will read **BEGIN SETUP OF (COFFEE NAME)**. Then the screen will display **BREW OZ.** and a batch light will be blinking. (Refer to **BREW OZ (SETTING OR ADJUSTING** for description).

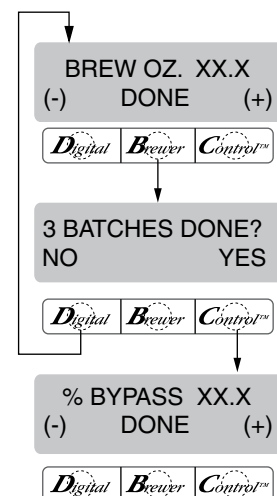

P2415

## PROGRAMMING THE BREWER (cont.)

### SET NEW RECIPE (cont.)

8. Using (-) and (+), set the amount of brew water, in ounces, to be dispensed for that particular batch size.
9. When finished, press another batch size and repeat step 8 for that size. Continue setting all batch sizes.
10. When finished setting all batch sizes, press and release **DONE**. The display should read **3 BATCH SIZES DONE?**
11. If the three batch sizes are not correct, press and release **NO** to return to the **BREW OUNCES** setup screen and repeat steps 8 through 10. If the three batch sizes are correct, press **YES**. This will advance to the **% BYPASS** function. (Refer to **% BYPASS** for description).

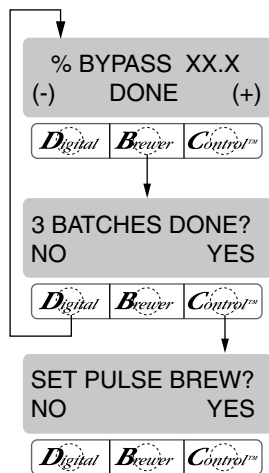

P2416

12. Using (-) and (+) set the amount of bypass water (percentage) to be dispensed **around** the grounds for that particular batch size.
13. When finished, press another batch size and repeat step 12 for each batch to be set.
14. When finished setting each batch size, press **DONE**. The display should read **3 BATCHES DONE?**
15. If the three batch sizes are not correct, press and release **NO** to return to the **% BYPASS** setup screen and repeat steps 12 through 15. If they are correct, press **YES**. This will advance to **SET PULSE BREW**. (Refer to **SET PULSE BREW** for description).
16. To **SET PULSE BREW**, if setting pulse brew using **EASY METHOD** (brewing into a funnel) press **YES** and proceed with the setup instructions for **SET PULSE BREW - EASY METHOD**.
17. If setting pulse brew by **MANUAL METHOD** (entering known times) press **MANUAL** then **NEXT** and proceed with the setup instructions for **SET**

**PULSE BREW - MANUAL METHOD. SET DRIP TIME.** (Refer to **SET DRIP TIME** for description).

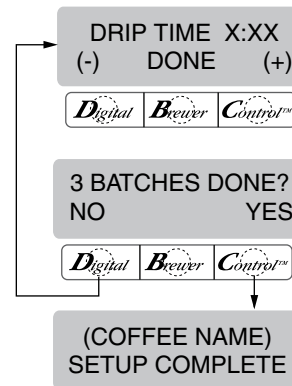

P2418

18. The display should now read **DRIP TIME**, along with either the word **OFF**, or a time will be showing. A batch light should also be blinking.
19. Using (-) and (+), set the amount of time from when the brew spray ends to when the funnel is emptied of hot liquid for that batch size.

**NOTE:** Set to **OFF** to prevent funnel locks from engaging (to disable this function), for a particular batch size. To set to **OFF**, continue to press and release (-) until **OFF** appears on the screen.

20. When finished, press another batch size and repeat step 19 until all three sizes are set.
21. When finished setting all batch sizes press **DONE**. The display should read **3 BATCHES DONE?**
22. If the three batch sizes are not correct, press **NO** to return to the **DRIP TIME** setup screen and repeat steps 19 through 21.
23. If the three batch sizes are correct, press **YES**. The screen should show the name of the coffee being programmed (modified) along with **SETUP COMPLETE**.
24. After a 5 second delay, the display will advance to the next coffee name in the brewer's memory. If no other coffee names are present, the display will read **THAT WAS THE LAST RECIPE**, and return to the **REVIEW RECIPES** screen.



## PROGRAMMING THE BREWER (cont.)

### SET NEW RECIPE

Using a **RECIPE CARD** to load coffee names and brew settings into the **SINGLE TF DBC** or **DUAL TF DBC with Smart Funnel**:

The G9-2T DBC or MHG's memory contains certain coffee names. If the operator uses a coffee name that is not already stored in the grinder's memory, a **RECIPE CARD** can be obtained from the factory. The **RECIPE CARD** would include all the information needed to set up that particular coffee name. The information from the **RECIPE CARD** is loaded into the grinder's memory, then into the brewer's memory by holding the chip area up to the equipment's sensing coil. This information can include the coffee name, **BREW VOLUMES**, **BYPASS PERCENTAGES**, **PULSE BREW TIMES** and **DRIP-OUT TIMES** for that particular coffee **NAME**. These can all be loaded in seconds.

Contact Bunn-O-Matic Corporation for the availability of **RECIPE CARDS**.

**NOTE:** Instructions to program the brewer and grinder are printed on the **RECIPE CARD**, along with the coffee name that is being programmed.

#### Procedure to program the coffee name:

1. Remove the funnel(s) (if present) from the funnel rails (both sides on DUAL brewers).
2. Position the **RECIPE CARD** vertically, so that the top end of the **CHIP** is beneath the left side funnel sensing coil.
3. After a short pause the display will read **CARD CONTAINS RECIPE FOR** then will change to **(COFFEE NAME) SHOW QUIT SAVE**. All brewing parameters for that coffee name are now transferred from the **CARD** to the brewer.
4. To show (view) this information, press and release **SHOW**. The display will scroll through all of the brew settings for all three batch sizes. The display will then return to **CARD CONTAINS RECIPE FOR** then will change to **(COFFEE NAME) SHOW QUIT SAVE**.
5. If all brew settings are correct, press **SAVE**. The display will read **(COFFEE NAME) SETUP COMPLETE**. All brew settings for that name are now stored in the brewer's memory.

6. If the brewing information is not correct, or it is desired to exit the setup before the settings are loaded into the brewer's memory, press **QUIT**. The display will read **(COFFEE NAME) NOT SAVED**. The display will then return to the **MAIN SCREEN**.

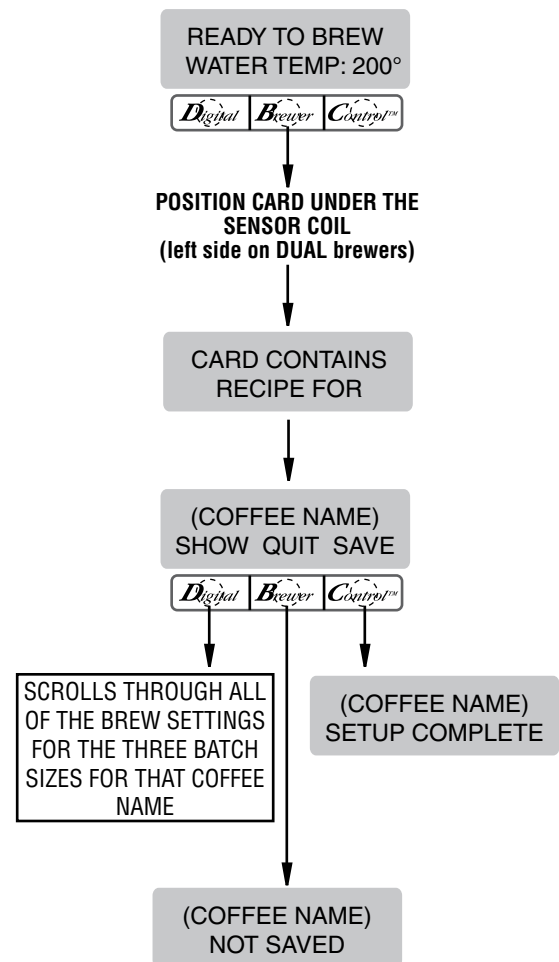

## PROGRAMMING THE BREWER (cont.)

### SET NEW RECIPE:

If not using a Smart Funnel (with a computer chip) and/or a G9-2T DBC or MHG Grinder, the brewer will function as a standard Bunn SINGLE TF/DUAL TF Brewer:

It is possible to operate the brewer without using a Smart Funnel and/or a G9-2T DBC or MHG Grinder. If a standard funnel, or if a non-DBC grinder is used the brewer will automatically select a **NO NAME** coffee when the BREW switch is pressed. This means that no name was read from the funnel's handle.

There is a **NO NAME** coffee program that can be set in the SINGLE brewer and two **NO NAME** coffee programs that can be set in the DUAL brewer which are referred to as **NO NAME LEFT** and **NO NAME RIGHT**. The left and right sides of the brewer can be set up independently of each other. This includes **BREW VOLUMES, BYPASS PERCENTAGES, PULSE BREW TIMES, and DRIP-OUT TIMES**. The brewer will perform in the same capacity as a standard Bunn Single/Dual Brewer.

The instructions for programming the **NO NAME** settings are on the following pages. The same steps are followed for setting the recipe as those that are used to **MODIFY A RECIPE**, beginning on page 21.

Note that on SINGLE brewers, when the display reads **NO NAME**, that is when **MODIFY** should be pressed in order to set the parameters for the **NO NAME** coffee.

On DUAL brewers, when the display reads **NO NAME LEFT**, that is when **MODIFY** should be pressed in order to set the parameters for the **NO NAME LEFT** coffee. Otherwise, press **NEXT** to display **NO NAME RIGHT**. At this point, **MODIFY** should be pressed in order to set the parameters for the **NO NAME RIGHT** coffee.

**NOTE:** Before beginning setup, insert funnel(s) into the funnel rails (both sides on DUAL brewers), and place a ThermoFresh Server(s) beneath the funnel(s).

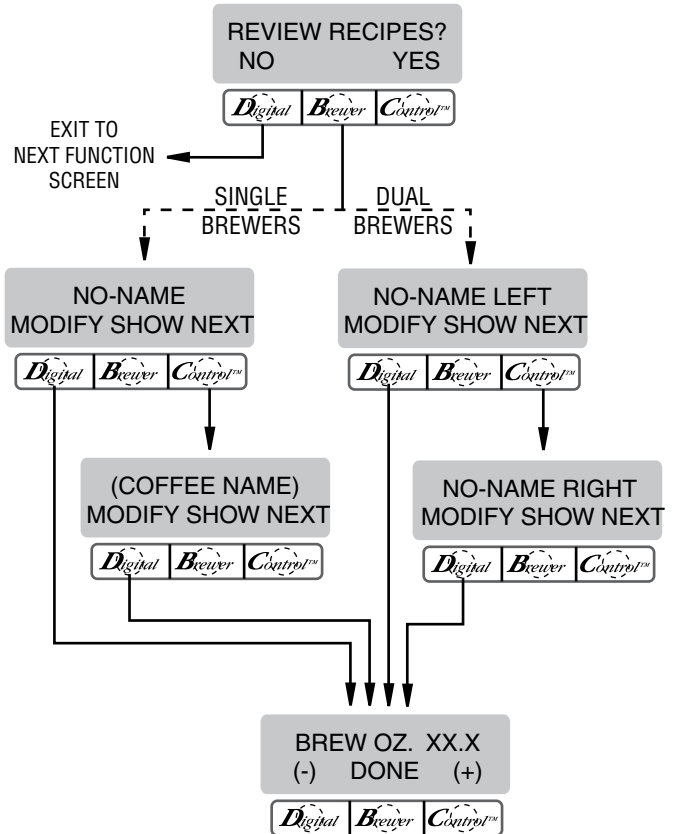



## PROGRAMMING THE BREWER (cont.)

### REVIEW RECIPES/MODIFY RECIPES/SET UP NO NAME COFFEE FAVORS:

This function has three parts. It allows the operator to view the brew settings for the various coffee names programmed into the brewer.

It also allows the operator to modify (change) any of the **BREW VOLUMES**, **BYPASS PERCENTAGES**, **PULSE BREW TIMES**, and **DRIP-OUT TIMES** for a particular coffee name programmed into the brewer.

Finally, this function is used to set up the **NO NAME** coffee **BREW VOLUMES**, **BYPASS PERCENTAGES**, **PULSE BREW TIMES**, and **DRIP-OUT TIMES**.

#### Procedure for reviewing recipes:

1. Press and hold upper right hidden switch (Ⓜ) until the display reads **UNITS**. Release the switch, then press and release switch until the display reads **REVIEW RECIPES**.
2. Press **YES** to proceed. The display should now read:  
**NO NAME**, along with **MODIFY**, **SHOW** and **NEXT** (SINGLE brewers)  
**NO-NAME LEFT**, along with **MODIFY**, **SHOW** and **NEXT** (DUAL brewers).

3. Press and release **SHOW**. The screen will scroll through all the brew settings for that particular coffee name. When finished, the display will return to the coffee name just viewed.
4. To see settings again, press **SHOW**. To advance to the next coffee name, press **NEXT**.
5. To exit, press **NEXT** until the display reads **THAT WAS THE LAST RECIPE**.
6. After 5 seconds, the display will return to the **REVIEW RECIPES** screen. Press and release **NO** to advance to the next function screen, or press and release the ON/OFF switch (either on DUAL brewers) located on the front switch panel to exit the programming mode and return to the **MAIN SCREEN**.

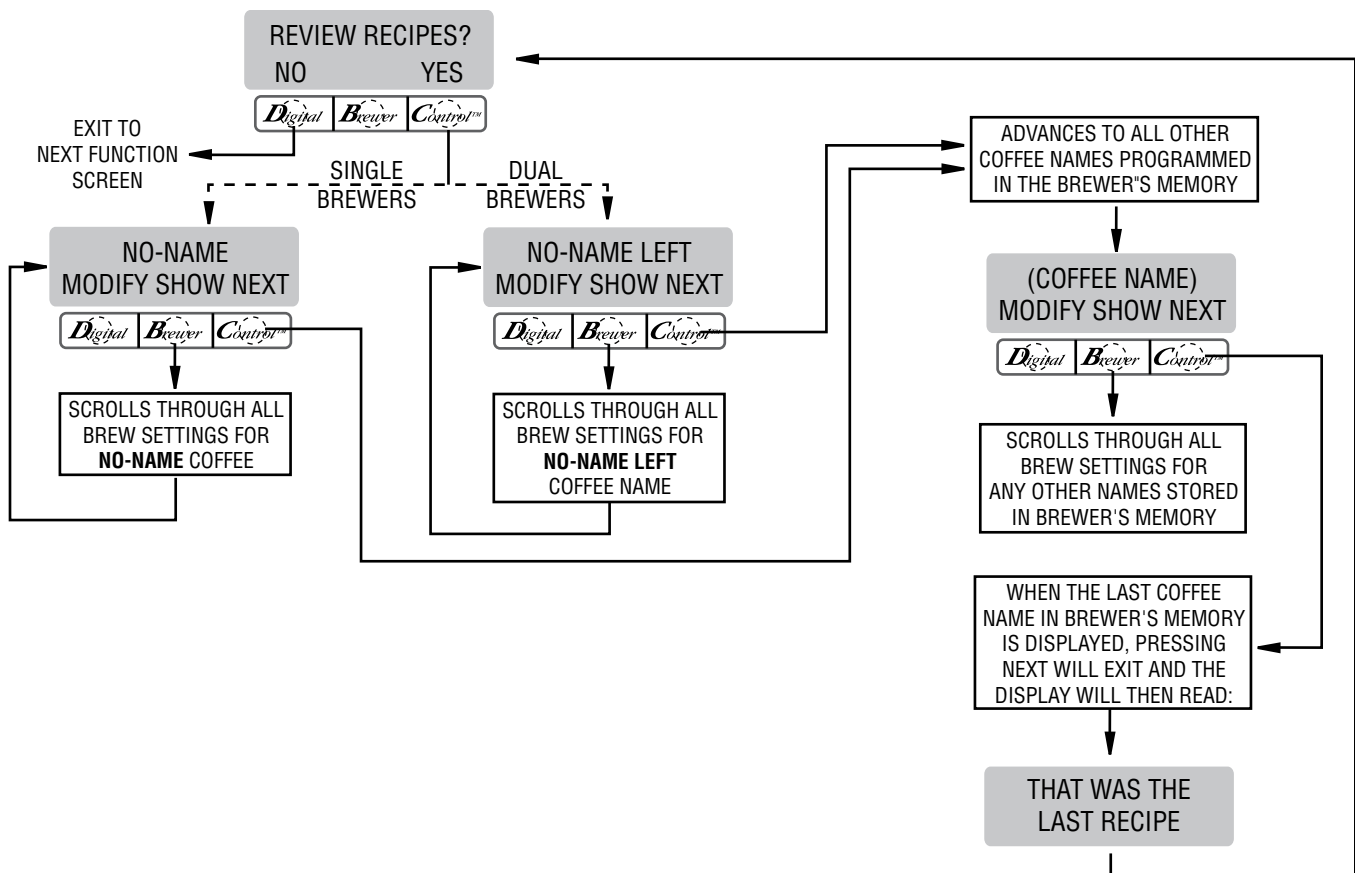

## PROGRAMMING THE BREWER (cont.)

### BREW OZ (SETTING OR ADJUSTING BREW VOLUMES)

This function allows adjustment of the brew volumes for each batch. The indicator signifies volume in ounces per batch.

#### Procedure for modifying recipes - brew ounces: Range: 10.0 oz to 400 oz for all three batch sizes

1. Press and hold upper right hidden switch (Ⓜ) until the display reads **UNITS**. Release the switch, then press and release switch until the display reads **REVIEW RECIPES**.
2. Press **YES** to proceed. The display should now read:  
**NO NAME**, along with **MODIFY, SHOW** and **NEXT** (SINGLE brewers)  
**NO-NAME LEFT**, along with **MODIFY, SHOW** and **NEXT** (DUAL brewers).
3. Press and release **NEXT** to advance to the desired coffee name to be modified.

4. Press and release **MODIFY**. The display should read **BREW OZ:** and a batch light will be blinking. Press and release the batch size to be modified.
5. Using **(-)** and **(+)**, set the amount of brew water, in ounces, to be dispensed **over** the grounds for that particular batch size.
6. When finished, press another batch size and repeat step 5 for that size for each batch size to be modified. Continue setting all batch sizes.
7. When finished setting all batch sizes, press and release **DONE**. The display should read **3 BATCH SIZES DONE?**
8. If the three batch sizes are not correct, press and release **NO** to return to the **BREW OUNCES** setup screen and repeat steps 5, 6 and 7.
9. If the three batch sizes are correct, press **YES**. This will advance to the **% BYPASS** function. Another alternative is to press and release the ON/OFF switch (either on DUAL brewers) to exit the **BREW OZ** setup and return to the **MAIN SCREEN**.

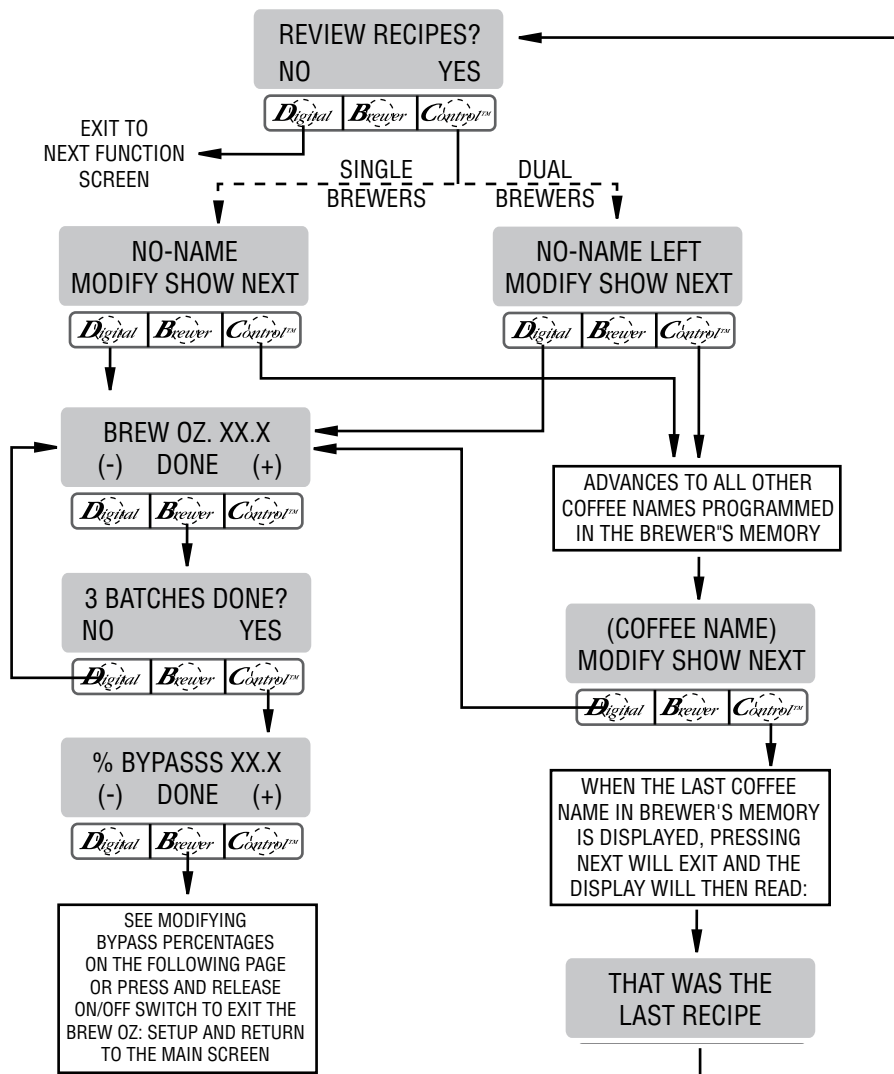

## PROGRAMMING THE BREWER (cont.)

### % BYPASS

This function allows adjustment of the amount of water that bypasses the grounds. The number signifies the percentage of the brew volume which does not flow over the coffee grounds.

#### Modifying recipes - bypass percentages:

**Range: 0% to 90% for all three batch sizes**

**NOTE:** If the brewer is already in the % BYPASS screen, it is not necessary to follow steps 1 through 6 in this section, but proceed directly to step 7.

1. Press and hold the upper right hidden switch (®) until the display reads **UNITS**. Release the switch, then press and release the switch until the display reads **REVIEW RECIPES**.
2. Press **YES** to proceed. The display should now read:  
**NO NAME**, along with **MODIFY, SHOW** and **NEXT** (SINGLE brewers)  
**NO-NAME LEFT**, along with **MODIFY, SHOW** and **NEXT** (DUAL brewers).
3. Press and release **NEXT** to advance to the desired

coffee name to be modified.

4. Press and release **MODIFY**. The display should read **BREW OZ.**
5. Press and release **DONE**. The display should read **3 BATCHES DONE?**
6. Press and release **YES**. The display should now read **% BYPASS**, and a batch light will be blinking. Press and release the batch size to be modified.
7. Using **(-)** and **(+)** set the amount of bypass water (percentage) to be dispensed **around** the grounds for that particular batch size.
8. When finished, press another batch size and repeat step 7 for each batch to be modified.
9. When finished setting all batch sizes, press **DONE**. The display should read **3 BATCHES DONE?**
10. If they are not correct, press and release **NO** to return to the **% BYPASS** setup screen.
11. If the 3 batch sizes are correct, press **YES**. This will advance to **SET PULSE BREW**. Another alternative is to press the ON/OFF switch (either on DUAL brewers) to exit % BYPASS setup and return to the **MAIN SCREEN**.

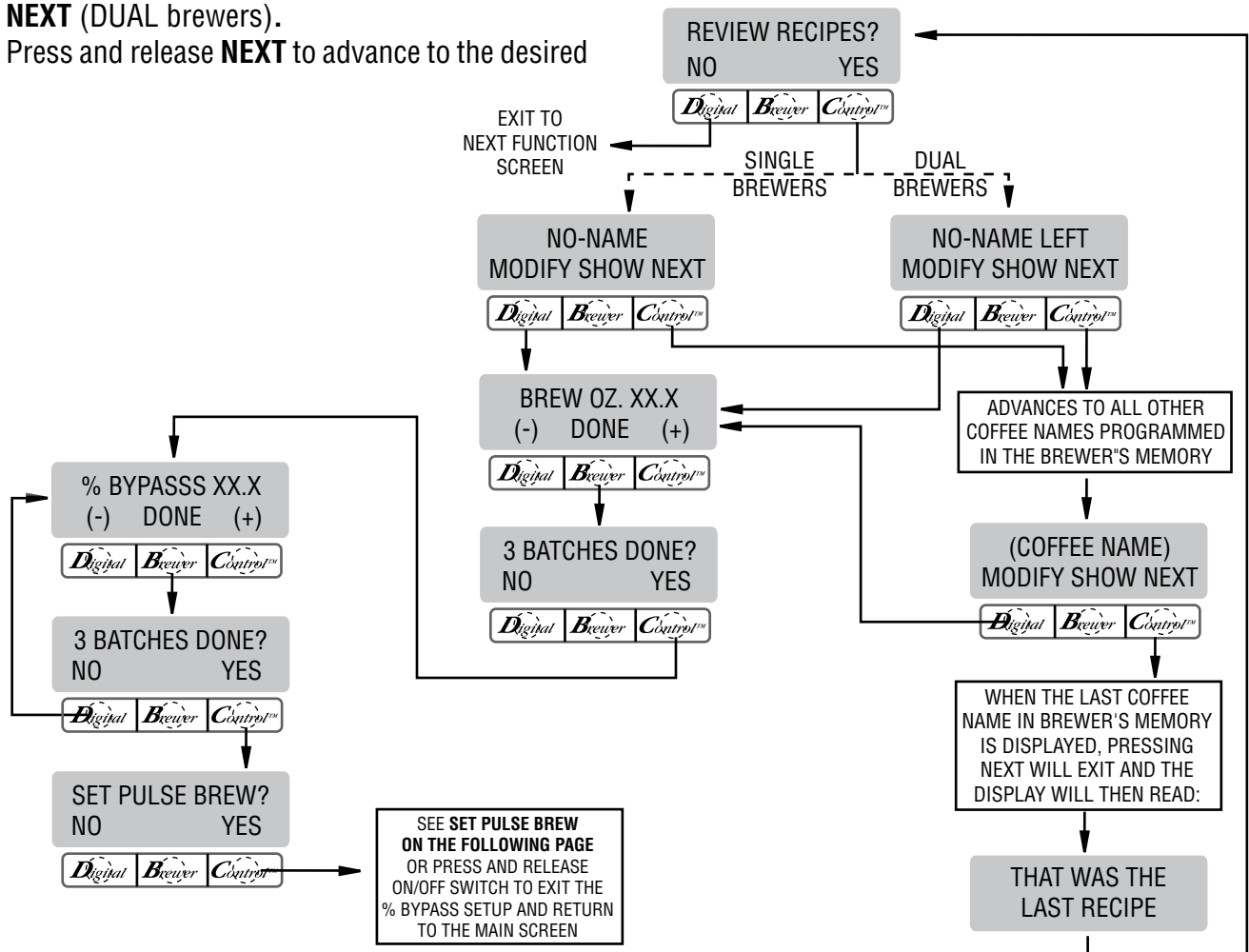

## PROGRAMMING THE BREWER (cont.)

### SET PULSE BREW:

This function allows the operator to program the brewer to "pulse" the sprayhead flow on and off during a brew cycle (start and stop the flow of water out of the sprayhead). This feature allows the ability to "fine-tune" the brewer for specific flavor profiles. Pulse brewing can be set up for any and all batches.

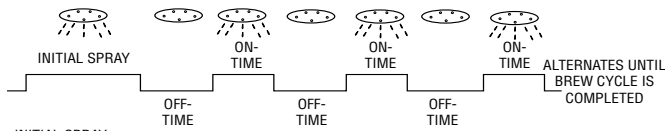

- 1st ON TIME** - This time is the duration from when the BREW switch is pressed to when the desired water level in the funnel is reached. (Soaking the grounds)
- OFF-TIME** - This time is the duration from when the water in the funnel reaches the desired **ON TIME** level to when it drains out of the funnel to a desired lower level.
- LAST ON-TIME** - This time is the duration from when the water in the funnel drains down to the lower level to when it fills the funnel to a desired higher level. (Soaking the grounds).

These three times can be set two different ways. The first is accomplished by utilizing the **EASY METHOD** and following the subsequent steps under that function.

The other allows the actual times to be entered for each of the settings. This is done by utilizing the **MANUAL METHOD** and following the subsequent steps under that function.

Either of these methods can be used to set the pulse brew for each batch.

### Modifying pulse brew:

**Range: 1st on time** - off to 4 minutes

**Off time** - off to 4 minutes

**Last on time** - Preinfusion to 4 minutes

**NOTE:** If the brewer is already in the **SET PULSE BREW** screen, it is not necessary to follow steps 1 through 8 in this section, but proceed directly to step 9.

- Press and hold the upper right hidden switch (®) until the display reads **UNITS**. Release the switch, then press and release the switch until the display reads **REVIEW RECIPES**.
- Press **YES** to proceed. The display should now read:  
**NO NAME**, along with **MODIFY, SHOW** and **NEXT** (SINGLE brewers)  
**NO-NAME LEFT**, along with **MODIFY, SHOW** and **NEXT** (DUAL brewers).
- Press and release **NEXT** to advance to the desired coffee name to be modified.
- Press and release **MODIFY**. The display should read **BREW OZ**.
- Press and release **DONE**. The display should read **3 BATCHES DONE?**
- Press and release **YES**. The display should now read **% BYPASS**.
- Press and release **DONE**. The display should read **3 BATCHES DONE?**
- Press and release **YES**. The display should now read **SET PULSE BREW**.
- Press and release **YES**. The display should now read **SELECT METHOD**.
- If setting pulse brew using **EASY METHOD** (brewing into a funnel) press **EASY** then **NEXT** and proceed with the setup instructions for *SET PULSE BREW - EASY METHOD*.
- If setting pulse brew by **MANUAL METHOD** (entering known times) press **MANUAL** then **NEXT** and proceed with the setup instructions for *SET PULSE BREW - MANUAL METHOD*.

# PROGRAMMING THE BREWER (cont.)

## SET PULSE BREW (cont.)

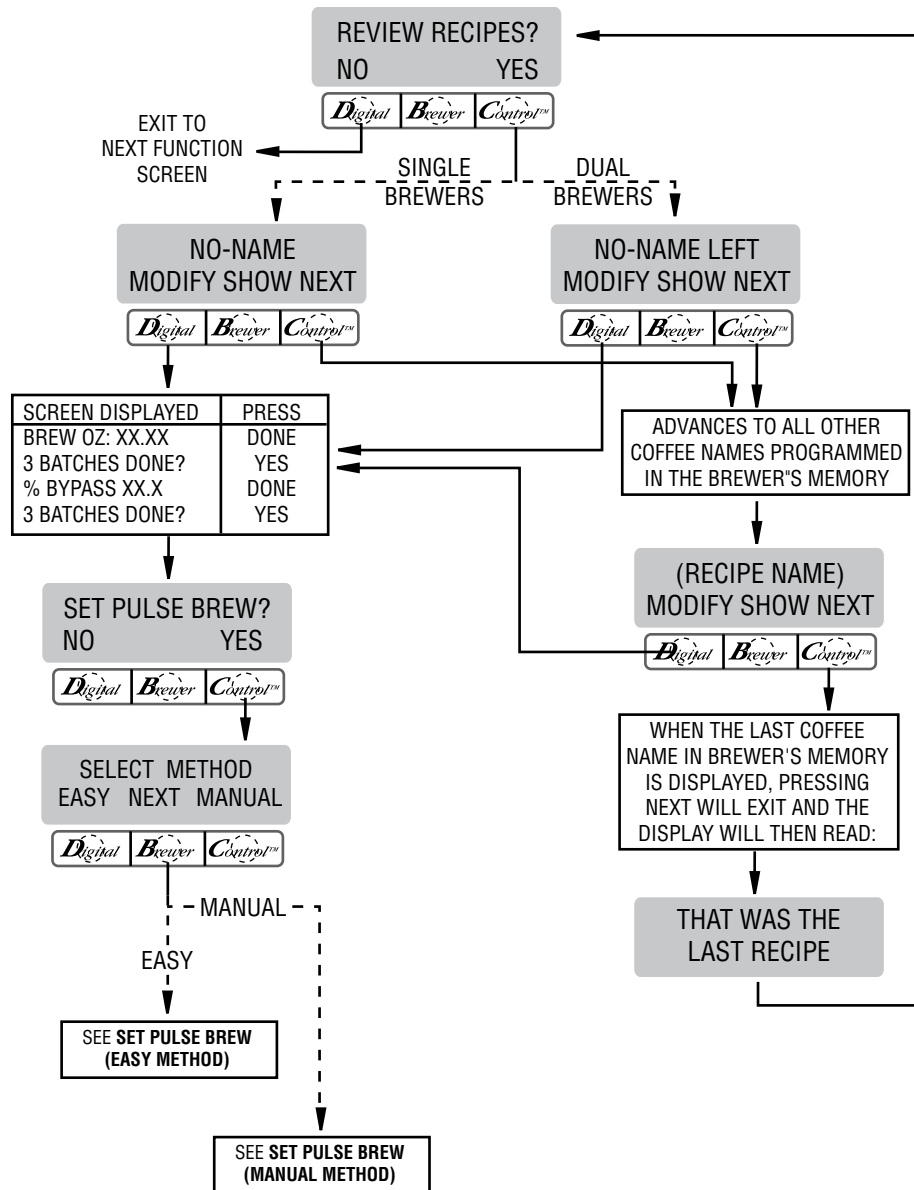

## PROGRAMMING THE BREWER (cont.)

### SET PULSE BREW - EASY METHOD

**NOTE:** The procedure to enter the *PULSE BREW* function must be performed prior to following the steps listed below.

1. The display should read **BREW TIME: X.XX** and a batch size indicator will be flashing.
2. Using (-) and (+), set the desired brew time for the selected batch size.
3. When finished, select another batch size to be set by pressing the switch next to the indicator light. Repeat step 2 for each batch size to be set.
4. When finished setting all batch sizes, press done. This will display the **1st, OFF, and LAST** times for 5 seconds, then advance to **3 BATCHES DONE ?**.
5. If the three batch sizes are not correct, press and release **NO** to return to **SELECT METHOD** setup screen and repeat steps 2 thru 4. If they are correct, press **YES**. This will advance to the **DRIP TIME** setup. (See *DRIP TIME SET UP*)

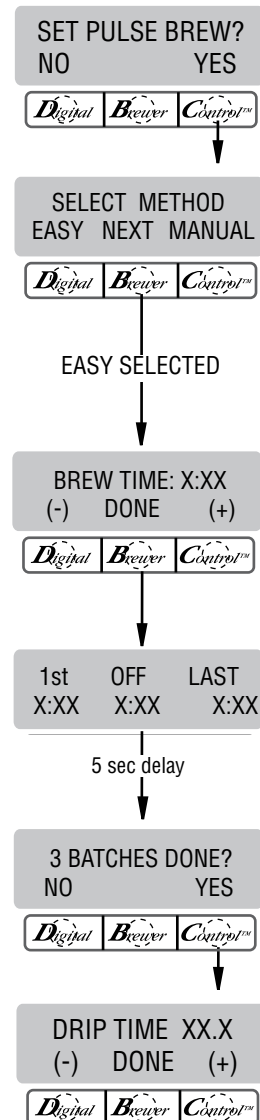

## PROGRAMMING THE BREWER (cont.)

### SET PULSE BREW - MANUAL METHOD

**NOTE:** The procedure to enter the *PULSE BREW* function must be performed prior to following the steps listed below.

1. The display should read **1st ON TIME X:XX** and a batch size indicator will be flashing.
2. Using (-) and (+) set the amount of time the flow of water into the funnel will be on.
3. When finished, press **DONE**. The display will now read **OFF TIMES: X:XX**.
4. Using (-) and (+) set the amount of time the flow of water into the funnel will be off.
5. When finished, press **DONE**. The display will now read **LAST ON: X:XX**
6. Using (-) and (+) set the amount of time the water will be on to complete the brew.
7. When finished, press **DONE**. The display will show the three times just entered for that batch size. After a 5 second delay, the display will read **3 BATCHES DONE?**
8. If other batch sizes need to be modified, press **NO**.
9. Press a different batch size and repeat steps 3 through 7. Repeat until all the desired batch sizes are set.
10. When finished press **YES** in **3 BATCHES DONE?**. The display will then read **DRIP TIME**.
11. Press and release the ON/OFF switch (either on DUAL brewers) located on the front switch panel to exit the **SET PULSE BREW** function and return to the **MAIN SCREEN**.

**NOTE:** Pressing the upper right hidden switch before reaching the final setting screen exits the setup and retains the old values.

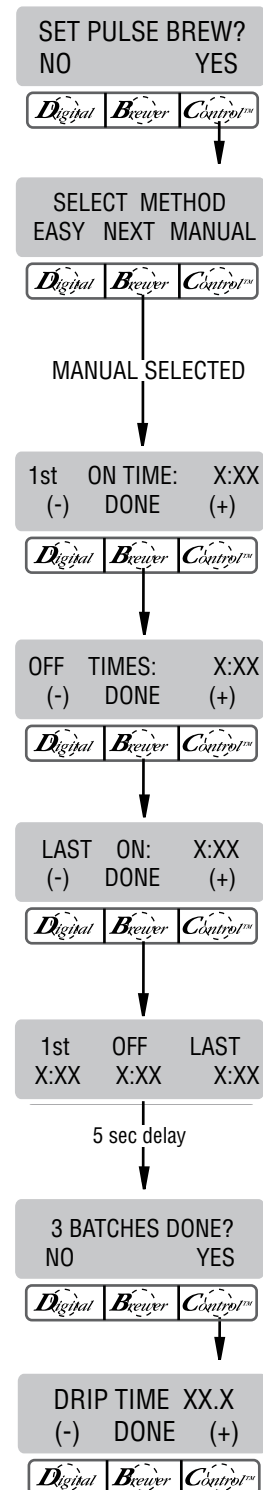

## PROGRAMMING THE BREWER (cont.)

### DRIP TIME (now displayed on "non" funnel lock units as well)

This function allows the setting or modification of the funnel locks to stay engaged after the end of a brew cycle. This ensures the funnel cannot be removed until after the liquid has emptied out of the funnel.

#### Procedure to modify drip times:

**Range:** OFF to 10 minutes for all three batch sizes.

**NOTE:** If the brewer is already in the **DRIP TIMES** screen, it is not necessary to follow steps 1 through 9 in this section, but proceed directly to step 10.

1. Press and hold the upper right hidden switch until the display reads **UNITS**. Release the switch. Press and release switch until the display reads **REVIEW RECIPES**.
2. Press **YES** to proceed. The display should now read:  
**NO NAME**, along with **MODIFY, SHOW** and **NEXT** (SINGLE brewers)  
**NO-NAME LEFT**, along with **MODIFY, SHOW** and **NEXT** (DUAL brewers).
3. Press and release **NEXT** to advance to the desired coffee name to be modified.
4. Press and release **MODIFY**. The display should read **BREW OZ.**
5. Press and release **DONE**. The display should read **3 BATCHES DONE?**
6. Press and release **YES**. The display should now read **% BYPASS**.
7. Press and release **DONE**. The display should read **3 BATCHES DONE?**
8. Press and release **YES**. The display should now read **SET PULSE BREW**.
9. Press and release **NO**. The display should now read **DRIP TIME**, along with either the word **OFF**, or a time will be showing. A batch light should also be blinking.
10. Using the **(-)** and **(+)**, set the amount of time from when the brew solenoid shuts off to when drip-out occurs for that batch size.

**NOTE:** Set to **OFF** to prevent funnel locks from engaging (to disable this function), for a particular batch size. To set to **OFF**, press and release **(-)** until **OFF** is displayed.

11. When finished, press another batch size and repeat step 10 until all three sizes are set.
12. When finished, press **DONE**. The display should read **3 BATCHES DONE?**
13. If the three batch sizes are set correctly, press **YES**. The screen should show the name of the coffee flavor being programmed (modified) along with **SETUP COMPLETE**.
14. After a 5 second delay, the display will advance to the next coffee name in the brewer's memory. If no other coffee names are present, the display will read **THAT WAS THE LAST RECIPE**, and return to the **REVIEW RECIPES** screen.

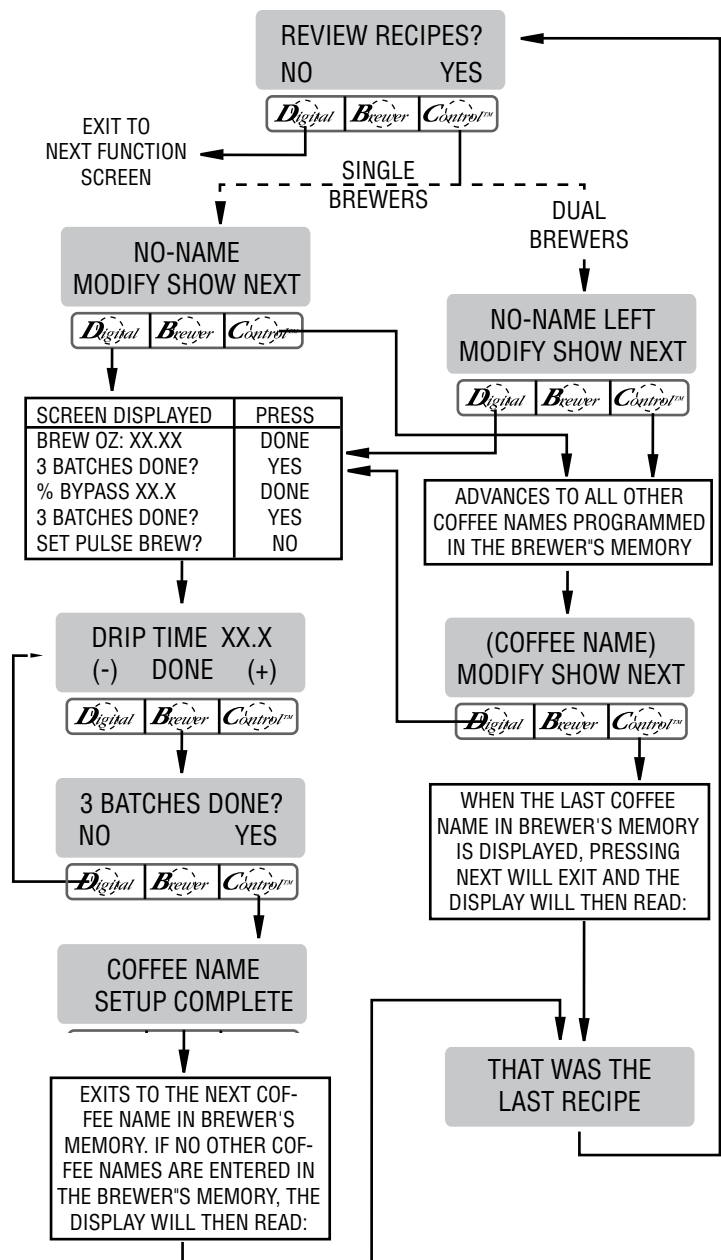



## PROGRAMMING THE BREWER (cont.)

### ASSIGN RECIPES

This function allows for assigning a coffee name other than **NO-NAME** to the **BREW** switch.

#### Procedure to assign recipes:

1. Press and hold the upper right hidden switch until the display reads **UNITS**. Release the switch. Press and release switch until the display reads **ASSIGN RECIPE ?**.
2. Press **YES** to assign a recipe to the BREW switch (left BREW switch on DUAL brewers).
3. Use **(-)** and **(+)** to select recipe which you want to assign to the BREW switch.
4. For SINGLE brewers, press and release **DONE** when selected to advance to next function screen, **ENABLE ADS**. For DUAL brewers, repeat process for right BREW switch recipe selection.

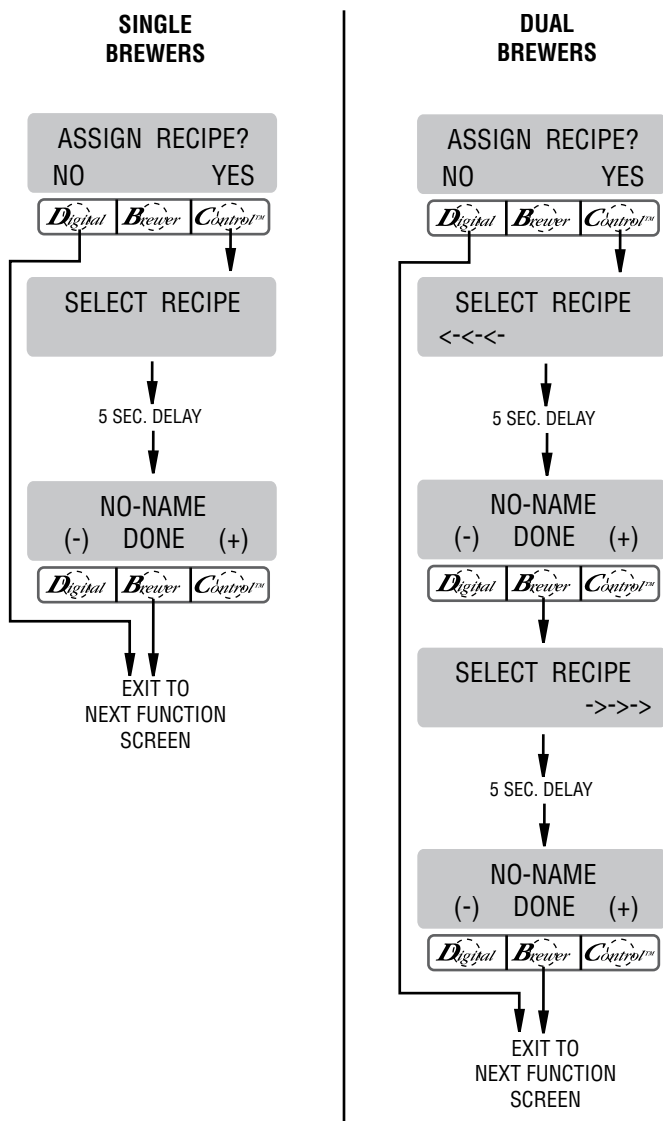

### COPY SETTINGS (NO NAME COFFEE SETTINGS ONLY)

This function is used on **DUAL brewers only** to transfer all the brew settings from a **NO NAME** coffee flavor programmed on one side of the brewer to the other side. A **NO NAME** coffee is a flavor that is not in the grinder's memory or is what appears if a Smart Funnel is not used.

For example, once the left side's 3 batch sizes are programmed (brew volumes, bypass percentages, pulse brew times, pre-infusion times, and drip-out times) for a particular **NO NAME** coffee, all the data can be transferred from the left side of the brewer to the right side in one step. The data can also be transferred from right to left, if the right side had been the initial set-up side. This results in less set-up time.

If two different **NO NAME** setups are required, one on the left, the other on the right side, it is not recommended that this function be used.

#### Procedure to copy settings:

1. Press and hold the upper right hidden switch until the display reads **UNITS**. Release the switch. Continue to press and release switch until the display reads **COPY SETTINGS**.

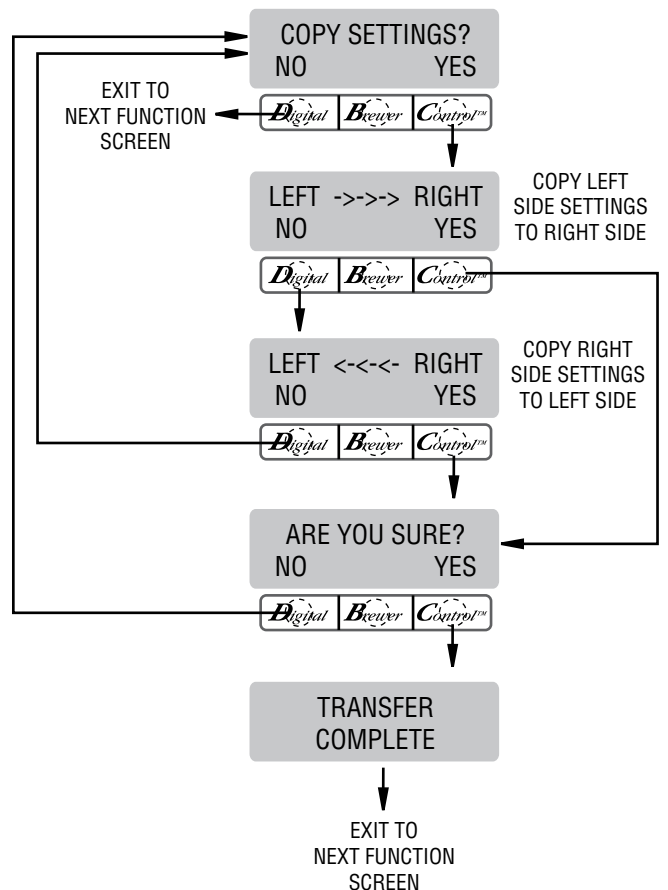

## PROGRAMMING THE BREWER (cont.)

### COPY SETTINGS (NO NAME COFFEE SETTINGS ONLY) (cont.)

- Press **YES** in this screen. The display should read **LEFT ->->-> RIGHT**.
- If the initial programming was done on the left side of the brewer, press **YES**. The display will read **ARE YOU SURE?**
- If you are sure that the data should be transferred from left to right, press **YES**. The display will then read **TRANSFER COMPLETE**, and will automatically advance to the next function screen.
- In the **LEFT ->->-> RIGHT** screen, if the programming was done on the right side and it is desired to transfer from right to left, press **NO**. The display will then read **LEFT <-<-<-< RIGHT**.
- If the initial programming was done on the right side of the brewer, press **YES**. The display will read **ARE YOU SURE?**
- If the data should be transferred from right to left, press **YES**. After the data is transferred, the display will read **TRANSFER COMPLETE**. This will appear for 3 seconds, then will exit to the next function screen. Brew settings for all flavors are not the same on both sides of the brewer, only the **NO NAME** setting has been transferred.

### ENABLE ADS?

This function allows the operator to choose whether or not to display the advertising message that was entered into the brewer with an **AD CARD**. This message will be displayed when the brewer is not in use.



#### Procedure to Enable/Disable Ads:

- Press and hold upper right hidden switch until the display reads **UNITS**. Release switch. Continue to press and release switch until the display reads **ENABLE ADS**. The **YES** or **NO** will be flashing to indicate the current selection.
- Press and release the **NO** to disable this function (no ads will be displayed on the screen), or;
- Press and release the **YES** to enable this function (ads will be displayed on screen).

- When finished, press and release **DONE** to save the new setting, exit the **ENABLE ADS** function and advance to the next function screen, **SET TEMP**. Another alternative is to press and release the ON/OFF switch (either on DUAL brewers) located on the front switch panel to exit the **ENABLE ADS** function and return to the **MAIN SCREEN**.

Brew water temperature is factory set at 205° F (96.1° C)  
Areas of high altitude will require lowering this temperature to prevent boiling. This chart should be used as a guide when readjusting the brew water temperature.

Altitude (Feet)	Boiling point of water		Recommended water temperature	
	° F	° C	° F	° C
-1000	213.8	101.0	200	93.3
-500	212.9	100.5	200	93.3
0	212.0	100.0	200	93.3
500	211.1	99.5	200	93.3
1000	210.2	99.0	200	93.3
1500	209.3	98.5	200	93.3
2000	208.4	98.0	200	93.3
2500	207.4	97.4	200	93.3
3000	206.5	96.9	199	92.8
3500	205.6	96.4	198	92.2
4000	204.7	95.9	197	91.7
4500	203.8	95.4	196	91.1
5000	202.9	94.9	195	90.6
5500	201.9	94.4	195	90.6
6000	201.0	93.9	194	90.0
6500	200.1	93.4	193	89.4
7000	199.2	92.9	192	88.9
7500	198.3	92.4	191	88.3
8000	197.4	91.9	190	87.8
8500	196.5	91.4	189	87.2
9000	195.5	90.8	188	86.7
9500	194.6	90.3	187	86.1
10000	193.7	89.8	186	85.6

### SET TEMP - Range: 185° F (85° C) to 205° F (96° C)

This function allows the operator to set the brew water temperature in the tank. It also sets the hot water faucet dispense temperature.



#### Procedure to set brew temperature:

- Press and hold upper right hidden switch until the display reads **UNITS**. Release switch. Continue to press and release switch until the display reads **SET TEMP**.

## PROGRAMMING THE BREWER (cont.)

### SET TEMP (cont.)

- To adjust the brew temperature, press **(-)** to decrease or **(+)** to increase the brew temperature.
- When finished, press and release **DONE** to save the new setting, exit the **SET TEMP** function and advance to the next function screen, **SET READY**. Another alternative is to press and release the ON/OFF switch (either on DUAL brewers) located on the front switch panel to exit the **SET TEMP** function and return to the **MAIN SCREEN**.

### SET READY - Range: 185°F (85°C) to 203°F (95°C)

This function allows the operator to set the minimum temperature allowable to start a brew cycle. The range can be from 185°F (85°C) to within 2°F (-1.7°C) of the **SET TEMP**. The water must be at the **SET READY** temperature or higher for the display to indicate **READY TO BREW**. If brew lockout is enabled, the brewing process will not start below this **READY** temperature.

**NOTE:** The upper limit for SET READY temperature is 2°F (-1.7°C) less than the water temperature (SET TEMP) setting.



#### Procedure to set ready temperature:

- Press and hold upper right hidden switch until the display reads **UNITS**. Release switch. Continue to press and release switch until the display reads **SET READY**.
- To adjust the ready temperature, press the **(-)** button to decrease, or **(+)** to increase the ready temperature.
- When finished, press and release **DONE** to save the new setting, exit the **SET READY** function and advance to the next function screen, **REFILL**. Another alternative is to press and release the ON/OFF switch (either on DUAL brewers) located on the front switch panel to exit the **SET READY** function and return to the **MAIN SCREEN**.

### REFILL - Range: 20 to 230

This function allows the operator to adjust the sensitivity of the refill circuit. This is mainly a troubleshooting feature. Water in different geographical locations can have different conductivities. By adjusting the sensitivity of the refill circuit, this will allow the brewer to operate under various water conditions.



#### Procedure to set the sensitivity threshold of the refill circuit:

**NOTE:** Make sure the water in the tank is touching the refill probe.

- Press and hold upper right hidden switch until the display reads **UNITS**. Release switch. Continue to press and release switch until the display reads **REFILL** and shows a number on both sides of the word.
- To adjust the threshold setting, press **(-)** to decrease, or **(+)** to increase the setting.

**NOTE:** Always make sure that the number on the right is larger than the number on the left when water is in contact with the refill probe in the tank.

- When finished, press and release **DONE**. This saves the new setting and advances to the next function screen:

**SPRY OZ/M** (SINGLE brewers)

**L SPRY OZ/M** (DUAL brewers). Another alternative is to press and release the ON/OFF switch (either on DUAL brewers) located on the front switch panel to exit **REFILL** and return to the **MAIN SCREEN**.

## PROGRAMMING THE BREWER (cont.)

### SPRAY OZ/M (SINGLE BREWERS)

This function allows the operator to view or to enter the actual flow rate coming out of the sprayhead. This is **NOT** used to change the actual flow rate, but to tell the internal controller how fast the water is flowing. The unit of measure is ounces per minute. (Oz/M)

#### Procedure to adjust the flow rate setting:

1. Press and hold the upper right hidden switch until the display reads **UNITS**. Release the switch, then press and release switch until the display reads **SPRAY OZ/M**. The number represents what the brewer thinks is the flow rate of the sprayhead valve in ounces per minute.
2. If the actual flow rate of the sprayhead valve is known, but is different than the number on the display, use the (-) and (+) to enter the correct flow rate in ounces per minute.
3. When finished, press and release **DONE**. This saves the new setting and advances to the next function screen, **BYPASS OZ/M**. Another alternative is to press the ON/OFF switch located on the switch panel to exit **SPRAY OZ/M** function and return to the **MAIN SCREEN**.

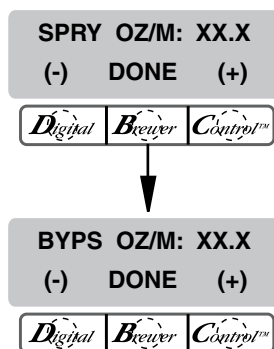

### SPRAY OZ/M (DUAL BREWERS)

This function allows the operator to view or to enter the actual flow rate coming out of the sprayhead. This is **NOT** used to change the actual flow rate, but to tell the internal controller how fast the water is flowing. The unit of measure is ounces per minute (Oz/M).

#### Procedure to adjust the flow rate setting:

1. Press and hold upper right hidden switch until the display reads **UNITS**. Release switch. Continue to press and release switch until the display reads, **L SPRY OZ/M**. The number represents what the brewer thinks is the flow rate of the sprayhead in ounces per minute.
2. If the actual flow rate of the sprayhead is known, but is different than the number on the display, use the (-) and (+) to enter the correct flow rate in ounces per minute.
3. When finished, press and release **DONE**. This saves the new setting and advances to **R SPRY OZ/M**. When finished setting the right side, press and release **DONE** to advance to next function screen, **L BYPS OZ/M**. Another alternative is to press and release either ON/OFF switch located on the front switch panel to exit **R SPRY OZ/M** function and return to the **MAIN SCREEN**.

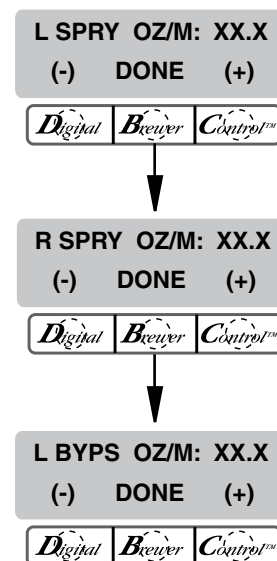

## PROGRAMMING THE BREWER (cont.)

### BYPASS OZ/M (SINGLE BREWERS)

This function allows the operator to view or to enter the actual flow rate coming out of the bypass nozzle. This is **NOT** used to change the actual flow rate, but to tell the internal controller how fast the water is flowing. The unit of measure is ounces per minute.

#### Procedure to adjust the flow rate setting:

1. Press and hold the upper right hidden switch until the display reads **UNITS**. Release the switch, then press and release switch until the display reads **BYPAS OZ/M**. The number represents what the brewer thinks is the flow rate of the bypass valve in ounces per minute.
2. If the actual flow rate of the bypass valve is known, but is different than the number on the display, use the (-) and (+) to enter the correct flow rate in ounces per minute.
3. When finished, press and release **DONE**. This saves the new setting and advances to the next function screen, **CALIBRATE FLOW**. Another alternative is to press the ON/OFF switch located on the front switch panel to exit the **BYPASS OZ/M** function and return to the **MAIN SCREEN**.

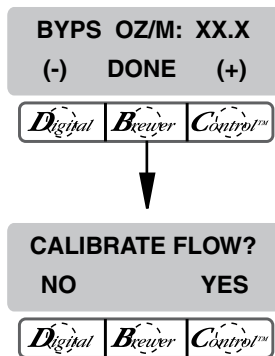

### BYPASS OZ/M (DUAL BREWERS)

This function allows the operator to view or to enter the actual flow rate coming out of the bypass nozzle. This is **NOT** used to change the actual flow rate, but to tell the internal controller how fast the water is flowing. The unit of measure is ounces per minute.

#### Procedure to adjust the flow rate setting:

1. Press and hold upper right hidden switch until display reads **UNITS**. Release switch. Continue to press and release switch until display reads **L BYPASS OZ/M**. The number represents what the brewer thinks is the flow rate of the bypass valve in ounces per minute.
2. If the actual flow rate of the bypass valve is known, but is different than the number on the display, use the (-) and (+) to enter the correct flow rate in ounces per minute.
3. When finished, press and release the **DONE**. This saves the new setting and advances to **R BYPS OZ/M**. When finished setting right side, press and release **DONE** to advance to next function screen, **CALIBRATE FLOW**. Another alternative is to press and release either ON/OFF switch located on the front switch panel to exit the **BYPASS OZ/M** function and return to the **MAIN SCREEN**.

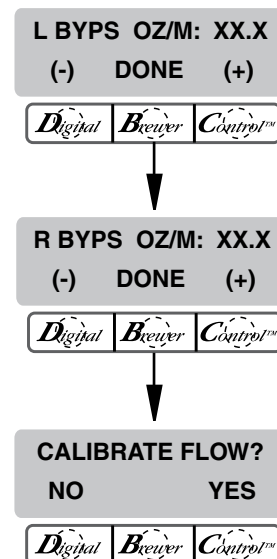

## PROGRAMMING THE BREWER (cont.)

### CALIBRATE FLOW

This function allows the operator to enter the actual flow rate of the sprayhead and the bypass (for each side on DUAL brewers) by dispensing both separately for one minute. The volumes are then entered in ounces per minute (OZ/M).

#### Procedures to calibrate the sprayhead flow rate:

1. Place a container, accurately graduated in ounces, and with a minimum capacity of 60 ounces, beneath the funnel (on the side to be calibrated on DUAL brewers) on the brewer.
2. Press and hold upper right hidden switch until the display reads **UNITS**. Release switch. Continue to press and release switch until display reads **CALIBRATE FLOW ?**.
3. Press and release **YES** to advance to the **SPRAY HEAD CAL?** function screen. (Pressing **NO** in the **CALIBRATE FLOW** screen will advance to the next function screen, **BREW COUNTERS**).
4. Press and release **YES**. The display should read **CONTAINER READY?** If the container is under the funnel, press **YES**. The display should read **CALIBRATE SPRAY .. PRESS BREW TO START**.
5. Press and release the BREW switch (on the side to be calibrated for DUAL brewers). The display should read **CALIBRATE SPRAY .. 60 SEC TO FINISH**. The 60 second timer on the display will count down to zero. When the counter reaches zero, the display will change to **ENTER OZ**, along with a number signifying ounces per minute.
6. Measure the amount of water in the container and using the (-) or (+), adjust the amount on the display to match the amount in the container. Then press **DONE**.
7. The display should now read:  
**NEW SPRAY FLOW** (SINGLE brewers)  
**NEW L or R SPRY FLOW** (DUAL brewers), along with the correct flow rate of the sprayhead in ounces per minute. After about 5 seconds, the display will return to the **CALIBRATE FLOW** screen.
8. Repeat steps 1 - 8 when calibrating the other side on DUAL brewers.
9. To exit the **CALIBRATE FLOW** program, press **NO** to advance to the next function screen, or press and release the ON/OFF switch (either on DUAL

brewers) located on the front switch panel to exit the **CALIBRATE FLOW** function and return to the **MAIN SCREEN**.

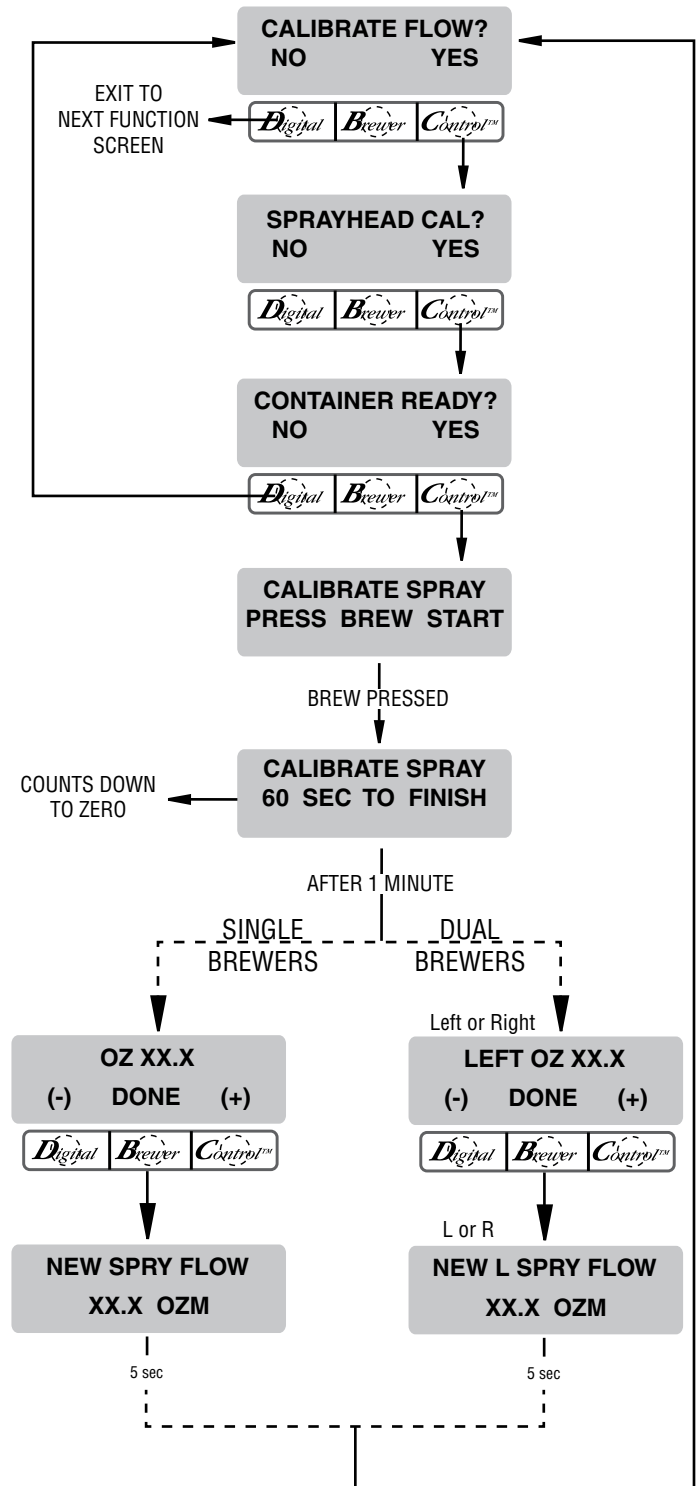



## PROGRAMMING THE BREWER (cont.)

### CALIBRATE FLOW (cont.)

#### Procedures to calibrate the bypass flow rate:

- Place a container, accurately graduated in ounces, and with a minimum capacity of 60 ounces, below the funnel on the brewer to be calibrated.
- Press and hold the upper right hidden switch until the display reads **UNITS**. Release the switch. Continue to press and release switch until the display reads **CALIBRATE FLOW?**.
- Press and release **YES** to advance to the **SPRAY HEAD CAL?** function screen. (Pressing **NO** in the **CALIBRATE FLOW** screen will advance to the next function screen, **BREW COUNTERS**).
- Press and release **NO** to advance to the **BYPASS CALIBRATION** screen.
- Press and release **YES**. The display should read **CONTAINER READY?** If the container is under the funnel, press **YES**. The display should read **CALIBRATE BYPASS .. PRESS BREW TO START**.
- Press and release the BREW switch (on the side to be calibrated on DUAL brewers). The display should read **CALIBRATE BYPASS .. 60 SEC TO FINISH**. The 60 second timer on the display will count down to zero. When the counter reaches zero, the display will change to:  
**ENTER OZ.** (SINGLE brewers)  
**LEFT or RIGHT OZ.** (DUAL brewers), along with a number.
- Measure the amount of water in the container, and using (-) or (+), adjust the amount on the display to match the amount in the container. Then press **DONE**.
- The display should now read:  
**NEW BYPS FLOW** (SINGLE brewers)  
**NEW L or R BYPS FLOW** (DUAL brewers), along with the correct flow rate of the bypass in ounces per minute. After about 5 seconds, the display will return to the **CALIBRATE FLOW** screen.
- Repeat steps 1 - 9 when calibrating the other side for DUAL brewers.
- To exit the **CALIBRATE FLOW** function, press and release **NO** to advance to next function screen, or press and release the ON/OFF switch (either on DUAL brewers) located on the front switch panel to exit the **CALIBRATE FLOW** function and return to the **MAIN SCREEN**.

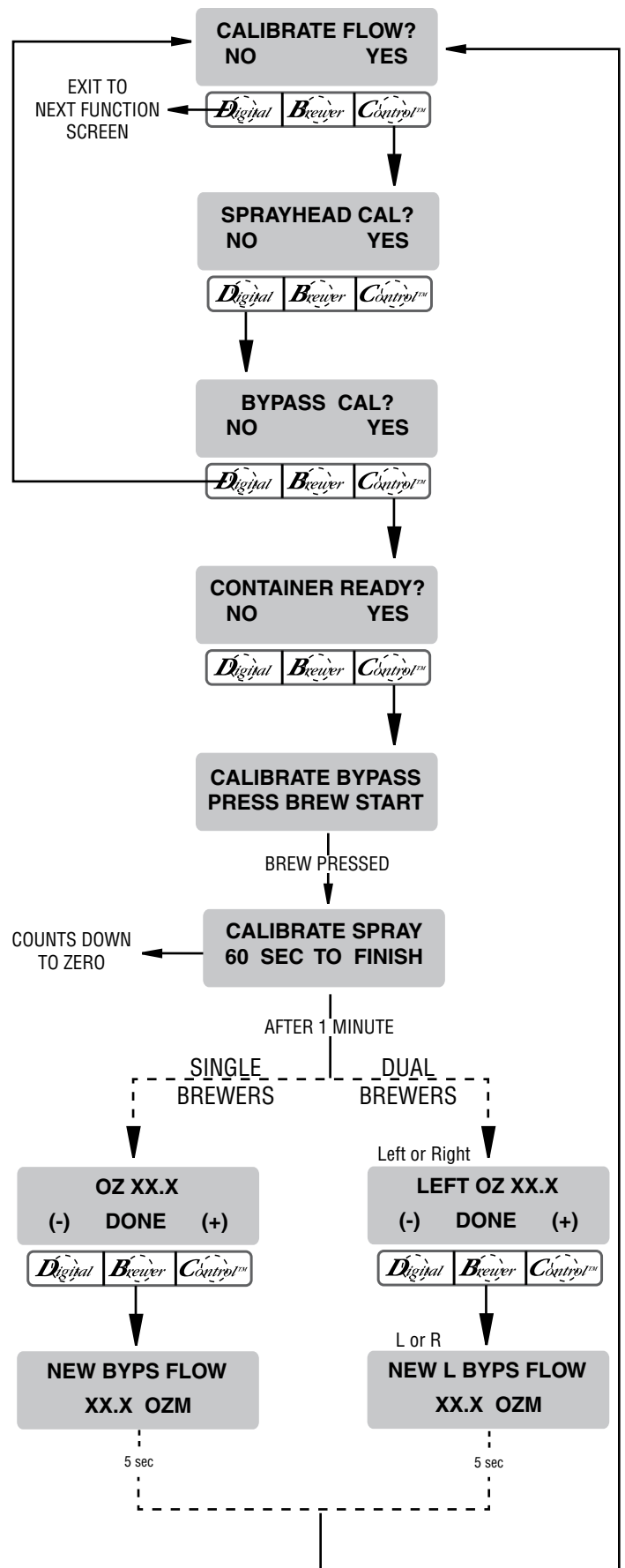

# PROGRAMMING THE BREWER (cont.)

## BREW COUNTERS

This function allows the operator to track the number of brew cycles completed. The number of brew cycles on the left side, the right side, and the total of both combined can be tracked on DUAL brewers. There is one resettable counter, and one life counter that is not resettable for SINGLE brewers and three resettable counters, and one life counter that is not resettable for DUAL brewers.

### Procedures to view/reset the brew counters:

1. Press and hold the upper right hidden switch until the display reads **UNITS**. Release the switch. Continue to press and release switch until the display reads **BREW COUNTERS**.
2. Pressing **NO** in this screen will advance to the next function. Press **YES** to view the first brew counter (left side on DUAL brewers). This number represents the brew cycles initiated since that counter was last reset.

3. To advance to the other counters, press and release **NEXT**. The four counters for DUAL brewers are as follows:
  - LEFT** - total brews on left side (resettable)
  - RIGHT** - total brews on right side (resettable)
  - LEFT AND RIGHT** - total brews on left and right sides combined (resettable)
  - LEFT AND RIGHT** - total brews on left and right sides combined (non-resettable)
4. To reset any of the counters to zero (except for the non-resettable counter), press and release **RESET** when viewing that particular counter's screen.
5. When finished, press **NEXT** to advance counter screens until the display reads **BREW COUNTERS**. Press and release **NO** to advance to the next function screen, or press and release the ON/OFF switch (either on DUAL brewers) on the front switch panel to exit the **BREW COUNTERS** function and return to the **MAIN SCREEN**.

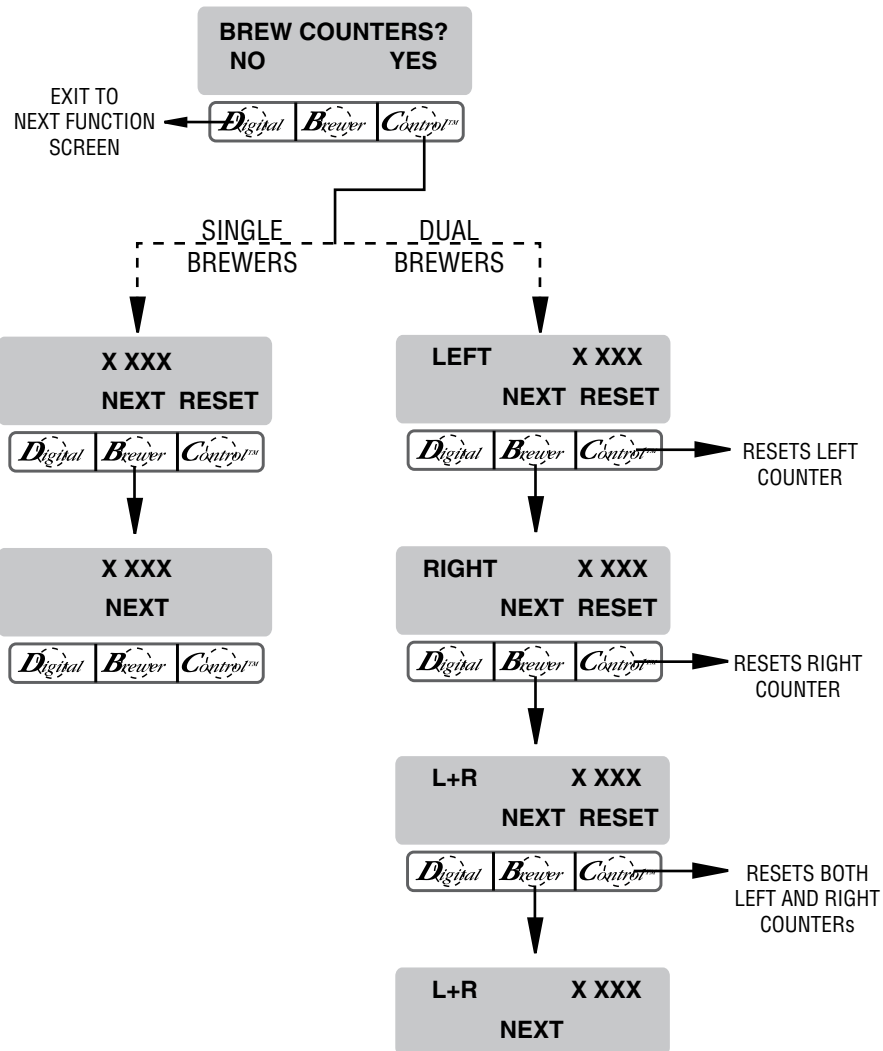



## PROGRAMMING THE BREWER (cont.)

### FUNNEL DETECT (optional)

This function allows the operator to prevent the start of a brew cycle if a Smart Funnel is not positioned correctly in the funnel rails.

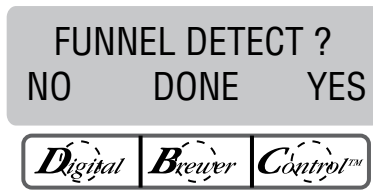

#### Procedure to set funnel detect:

1. Press and hold the upper right hidden switch until display reads **UNITS**. Release the switch. Continue to press and release switch until display reads **FUNNEL DETECT**.
2. **NO** or **YES** should be flashing to indicate the current setting.
4. Select **YES** to prevent brewing if a Smart Funnel is not correctly situated in the rails. If this function is activated and a brew cycle is attempted with the funnel not properly situated, the display will read, **FUNNEL NOT IN PLACE**, until one is in place.
5. Select **NO** to allow brewing without a Smart Funnel in place. This is selected when brewing with a funnel other than a Smart Funnel (a regular brew funnel).
6. When finished, press and release **DONE**. This will retain the changes, exit this function screen and advance to the next. Another alternative is to press the ON/OFF switch (either on DUAL brewers) located on the front switch panel to exit the **FUNNEL DETECT** and return to the **MAIN SCREEN**.

### SERVICE TOOLS

This function allows the testing of individual components and the ability to check switches for proper function. This function also tests the Soft Heat server's status on the brewer (in place or removed), and the funnel sensor coil's frequency (diagnostic tool for troubleshooting purposes only).

#### Testing individual components (outputs):

This will allow the operator to test the operation of individual components and outputs of the brewer. The components that can be individually tested are as follows:

#### SINGLE Brewers

Brew Valve  
Bypass Valve  
Funnel Lock (Optional)  
Refill Valve  
Tank Heaters  
Heater Contactor

#### DUAL Brewers

Left Brew Valve  
Left Bypass Valve  
Left Funnel Lock  
Right Brew Valve  
Right Bypass Valve  
Right Funnel Lock  
Refill Valve  
Tank Heaters  
Heater Contactor

#### Procedure to test components (outputs):

1. Place brew funnels into rails on both sides of brewer.
2. Place a server beneath each brew funnel.
3. Press and hold the upper right hidden switch until display reads **UNITS**. Release the switch. Continue to press and release switch until **SERVICE TOOLS** appears.
4. Press **YES** to run tests on various components and outputs within the brewer. Pressing **NO** will exit this function and advance to the next function screen.
5. The display should read **TEST OUTPUTS**.
6. Press and release **YES**. The display should read **LEFT BREW VALVE**.
7. To test **LEFT BREW VALVE**, press **ON**. If the brew valve is functional, water should run from the left brew side.
8. Press **OFF** to end flow of water.
9. Press **NEXT** to advance to the next component to be tested.

## PROGRAMMING THE BREWER (cont.)

### SERVICE TOOLS (cont.)

**NOTE:** To bypass testing any component, press **NEXT** to advance to the next one, without testing the previous component.

10. To test **LEFT BYPASS**, press **ON**. If the bypass valve is functional, water should run from the left brew bypass.
11. Press **OFF** to end flow of water.
12. Press **NEXT** to advance to the next component to be tested.
13. To test **LEFT FUNNEL LOCK**, press **ON**. If the funnel lock is functional, the lock will come down to hold the funnel in place.
14. Press **OFF** to retract the funnel lock.
15. Press **NEXT** to advance to the next component to be tested.
16. Follow steps 7 through 15 to test the right side components.
17. To test **REFILL VALVE**, press **ON**. If the refill valve is functional, the sound of the valve operating will be heard.
18. Press **OFF** to end testing of refill valve.
19. Press **NEXT** to advance to the next component to be tested.
20. To test **TANK HEATERS**, connect a voltmeter across each of the tank heaters to check for voltage.
21. Press **ON**. The correct voltage should be present at the heater terminals.
22. Press **OFF** to end testing of the tank heaters.

**NOTE:** The tank heater will automatically turn off if left on too long.

23. After testing the tank heater, press **NEXT** to advance to the next test.
24. The **HEATER CONTACTOR** is used only on certain models. Check the machine schematic to see if the contactor is present. Connect a voltmeter across a tank heater that is operated by the contactor and press **ON** to check that correct voltage is present. Press **OFF** and confirm the voltage is zero.
25. Press **NEXT** to return to **TEST OUTPUTS**.
26. To exit **SERVICE TOOLS**, press and release the ON/OFF switch (either on DUAL brewers) located on the front switch panel. This will return to the **MAIN SCREEN**.

### Procedure to test switches:

This function allows the operator to test the operation of the individual switches on the front panel.

1. Place brew funnel(s) into rails on the brewer (both sides on DUAL brewers).
2. Place a server beneath each brew funnel.
3. Press and hold the upper right hidden switch until display reads **UNITS**. Release the switch. Continue to press and release switch until **SERVICE TOOLS** appears.
4. Press **YES** to run tests on various components and outputs within the brewer. (Pressing **NO** will exit this function and advance to the next function screen.)
5. The display should read **TEST OUTPUTS**.
6. In **TEST OUTPUTS** screen, press **NO**. This advances to **TEST SWITCHES**.
7. Pressing **NO** in this screen will advance to the next function. Press **YES** in the **TEST SWITCHES** screen to test the switches. The display will read **NOTHING PRESSED**.
8. From this screen, press any of the switches on the front of the brewer except the upper right hidden switch. While the switch is pressed, the display shows the name of that switch. If the name does not appear, or if it remains after the switch has been released, the switch is defective. Each switch can be tested in this manner.
9. After all switches have been tested, press and release the right hidden switch (®). This will return to **TEST SWITCHES?**. Press and release switch again to advance to **TEST SERVERS?**. Another alternative is to press and release the ON/OFF switch (either on DUAL brewers) located on the front switch panel. This will exit **TEST SWITCHES** and return to the **MAIN SCREEN**.

### Procedures to test coil frequency:

1. Place brew funnel(s) into funnel rails of the brewer (both side on DUAL brewers).
2. Place a ThermoFresh server beneath brew funnel(s).
3. Press and hold the upper right hidden switch until the display reads **UNITS**. Release the switch. Continue pressing and releasing the upper right hidden switch until **SERVICE TOOLS** appears.
4. Pressing **NO** will exit this function and advance to

# PROGRAMMING THE BREWER (cont.)

## SERVICE TOOLS (cont.)

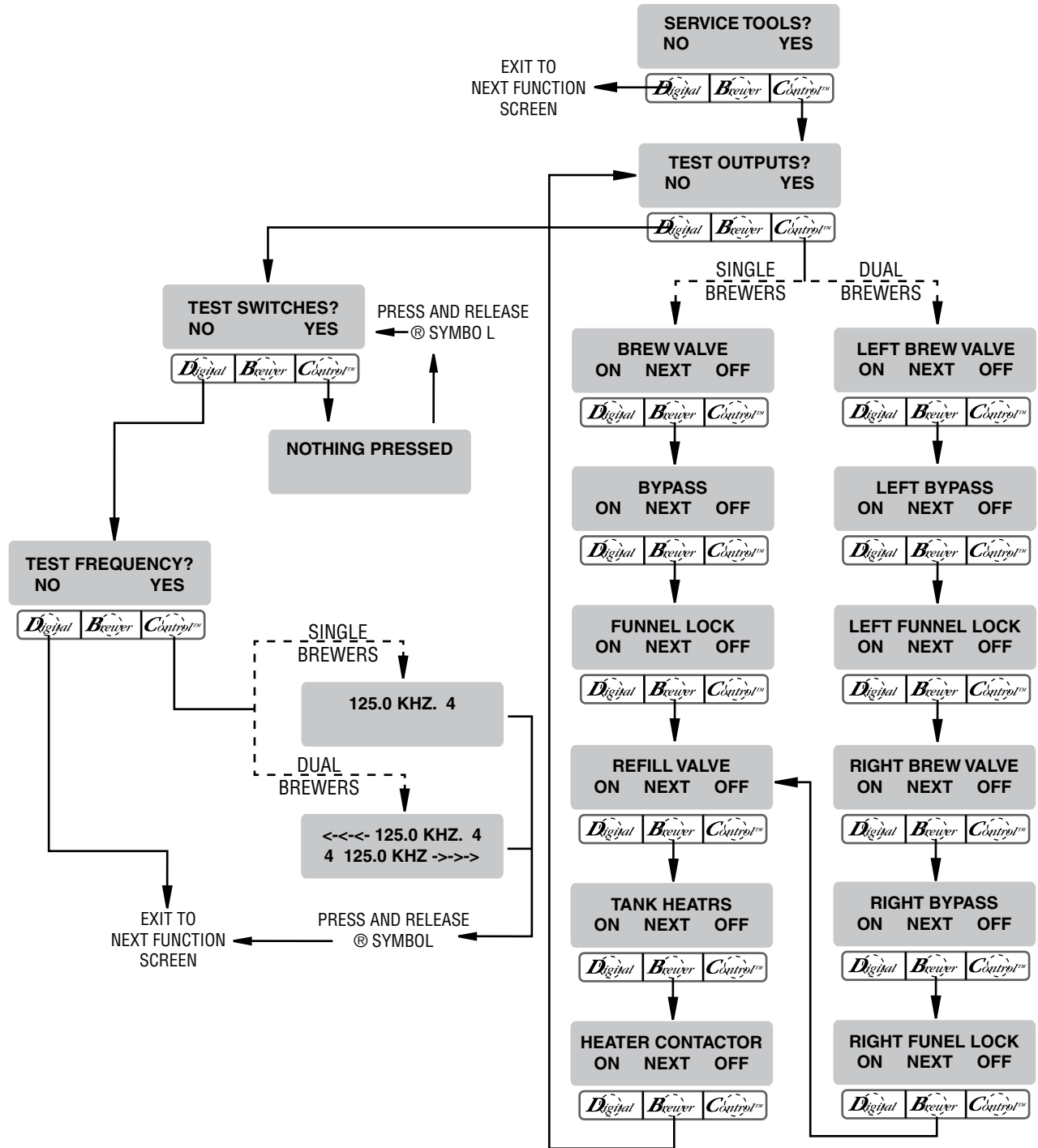

## PROGRAMMING THE BREWER (cont.)

### SERVICE TOOLS (cont.)

the next function screen. Press **YES** to run tests on various components and outputs within the brewer.

- The display should read **TEST OUTPUTS?**
- In **TEST OUTPUTS** screen, press **NO**. Continue to press and release **NO** until the display reads **TEST FREQUENCY?**
- Press and release **YES**. The display will show the frequency of the sensor coil circuits. This is for diagnostic service use when troubleshooting this circuit.
- After the coils have been tested, press and release the ON/OFF switch (either on DUAL brewers) located on the front switch panel. This will exit the **TEST FREQUENCY** function and return to the **MAIN SCREEN**.

**NOTE:** If the operator wishes to test more than one function in the **SERVICE TOOLS** section (outputs, switches, servers, or coil frequency), it is not necessary to exit the program. Use the flow chart for **SERVICE TOOLS** to navigate to a particular function.

### FACTORY DEFAULTS

This function allows the operator to erase **all** of the previously entered recipes and ad messages. Factory-set default values will replace **all** previous settings.

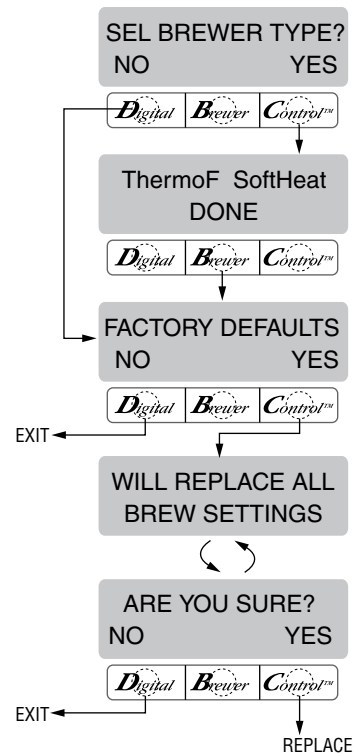

P2312

### Procedure to set factory defaults:

- Press and hold the upper right hidden switch until **UNITS** appears. Release the switch. Press and release the upper right hidden switch until the display reads **SEL BREWER TYPE?**
- Pressing **NO** in this screen will advance to **FACTORY DEFAULTS**. Press and release **YES**. The display should read **ThermoF SoftHeat**. The selected brewer type will be flashing. When correct brewer type is selected press **DONE**.
- The display should now read **FACTORY DEFAULTS**. Pressing **NO** in this screen will revert to the **MAIN SCREEN**. Press **YES** to replace the defaults. This advances to **WILL REPLACE ALL BREWING SETTINGS**. This screen will alternate with **ARE YOU SURE?**
- Pressing **NO** in the confirmation screen will revert to **MAIN SCREEN**, without resetting the brewing setups to the defaults. Press **YES** to load the defaults. This will then revert to the **MAIN SCREEN**, and the factory default values will replace **all** previously entered values. It will NOT reset the summation Brew counter.