

Worktop Refrigerators & Freezers



FWR/FWF Series • **FWR-27** • **FWR-48** • **FWR-60** • **FWR-72**
 • **FWF-27** • **FWF-48** • **FWF-60**

Standard Features

- Our undercounter units are designed with durability and strength that you will not find in any other products in this class.
- All stainless steel interior and exterior construction for a clean & safe food environment. Coved corner floor to meet NSF requirements.
- Heavy duty stainless steel door with full length recessed door handles; interior step design for added insulation and protection of door gasket.
- Factory balanced refrigeration system, environmentally friendly R-134A Refrigerators & R-404A Freezers.
- Refrigerators maintain product temperatures from 33° to 38°F. Freezers: -5°F, includes automatic defrost.
- Front breathing refrigeration system for built-in applications.
- 36" high working height with 4" backsplash.

Item # _____



FWR(F)-27



FWR(F)-48



FWR-72

Options & Accessories

- 6" adjustable legs (set of 4)
- Epoxy coated shelves (clips included)
- 16 gauge S/S top in lieu of std.
- Stainless steel back panel
- Single tier overshelf
- Double tier overshelf
- 220 volts / 50 cycles / 1 phase



* Conforms to UL & NSF-7 standards

ISO-9001

	Model	Door	Capacity (Cu.Ft.)	Shelves	Amps	HP	Voltage	Nema Plug	Cord Length	Cabinet Dimensions			Shipping	
										L	D*	H**	Wt.	Cubes
Refrigerator	FWR-27	1	6.1	2	2.7	1/6	115/60/1	5-15P	8'	27" (685.8 mm)	30" (762 mm)	35" (889 mm)	204 (92.5 kg)	21 (.60 m ³)
	FWR-48	2	11.8	4	5.4	1/4	115/60/1	5-15P	8'	48" (1219.2 mm)	30" (762 mm)	35" (889 mm)	289 (131 kg)	35 (.99 m ³)
	FWR-60	2	15.0	4	6.7	1/3	115/60/1	5-15P	8'	60" (1524 mm)	30" (762 mm)	35" (889 mm)	343 (156 kg)	47 (1.33 m ³)
	FWR-72	3	18.2	6	6.7	1/3	115/60/1	5-15P	8'	72" (1828.8 mm)	30" (762 mm)	35" (889 mm)	413 (188 kg)	56 (1.56 m ³)
Freezer	FWF-27	1	6.1	2	8.2	3/4	115/60/1	5-15P	8'	27" (686 mm)	30" (762 mm)	35" (889 mm)	214 (97 kg)	21 (.60 m ³)
	FWF-48	2	11.8	4	8.5	3/4	115/60/1	5-15P	8'	48" (1219 mm)	30" (762 mm)	35" (889 mm)	319 (144 kg)	35 (.99 m ³)
	FWF-60	2	15.0	4	8.5	3/4	115/60/1	5-15P	8'	60" (1524 mm)	30" (762 mm)	35" (889 mm)	373 (169 kg)	47 (1.33 m ³)

* Depth does not include 1" bumper. ** Height does not include 4" (5" overall) castors or 6" optional legs.

Specifications Work Tops

Construction

Heavy duty stainless steel exterior top, front and sides. Galvanized back panel. Interior completely constructed of heavy duty stainless steel with coved corner floor. 4" one piece fixed backsplash. Door is heavy duty stainless steel exterior and high impact ABS plastic interior, step design with stainless steel hinged solid doors and positive seal. Provided with magnetic door gaskets, removable without tools, self-closing and with 120° stay open feature. Recessed full length door handle. Door openings have a plastic breaker strips to retard condensate formation.

Unit comes complete with a 2" CFC-Free polyurethane insulation, foamed in place.

Refrigeration System

Self-contained capillary tube system using environmentally friendly (CFC Free) refrigerant. (R-134a Refrigerator / R-404a Freezers) Front breathing for built-in applications. Evaporator coil is mounted to interior top panel encased in stainless steel. Large fan motor and fan blades for better air flow.

Refrigerators are designed to maintain temperatures between 33° F to 38° F and freezers 0° to -5° F during normal operations. Digital controllers and thermostats on freezers, analog thermostats on refrigerators.

Shelving

(2) Epoxy coated shelving per door with clips. Adjustable in 1/2" increments per shelf.

Others

Unit is supplied standard with an 8' cord and plug (Nema 5-15p). Standard 4" diameter casters, front 2 with brakes.

Warranty

(24) month labor and parts warranty. 5 year compressor warranty (Continental U.S.A. & Canada only).

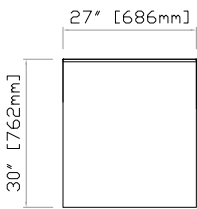

FWR(F)-27 Top View

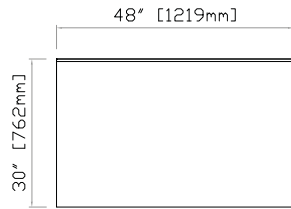

FWR(F)-48 Top View

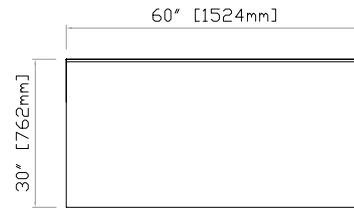

FWR(F)-60 Top View

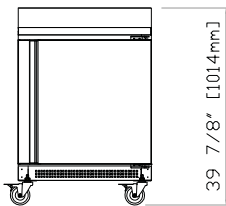

FWR(F)-27 Front View

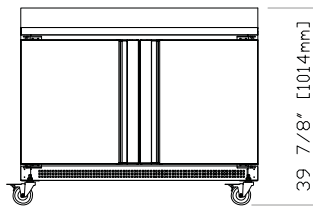

FWR(F)-48 Front View

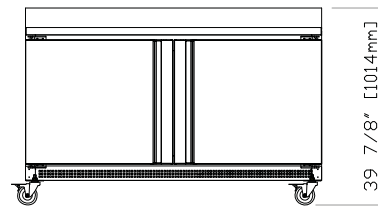

FWR(F)-60 Front View

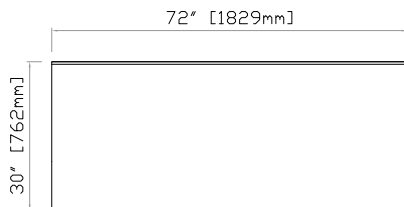

FWR-72 Top View

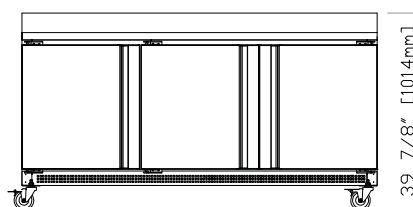

FWR-72 Front View

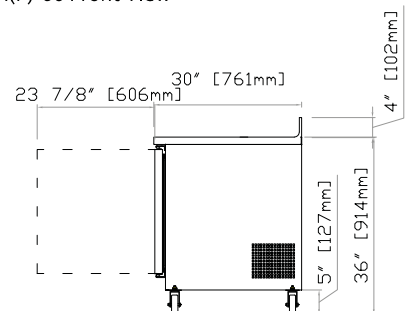

FWR(F)- Common View
End View

The manufacturer reserves the rights to modify materials and specifications without notice.

Printed in the USA • 09/12