



Instruction Manual

Hawaii's Finest

Model No. 1027HD, 1027HDX







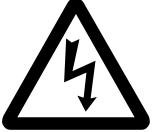

GOLD MEDAL® PRODUCTS CO.

10700 Medallion Drive, Cincinnati, Ohio 45241-4807 USA



SAFETY PRECUTIONS

	<p style="text-align: center;">⚠ DANGER</p> <p>Machine must be properly grounded to prevent electrical shock to personnel. Failure to do so could result in serious injury, or death. Do NOT immerse any part of this equipment in water. Do NOT use excessive water when cleaning. Keep cord and plug off the ground and away from moisture. Always unplug the equipment before cleaning or servicing.</p> <p style="text-align: right;">008GEND1012</p>
	<p style="text-align: center;">⚠ WARNING</p> <p>Never put your fingers or any object into the shaver body (the goose-neck or hopper) while the motor is running. Serious injury may occur. <i>(Gold Medal Products Company does not assume any liability for injury due to careless handling and/or reckless operation of this equipment.)</i></p> <p style="text-align: right;">017SW1012</p>
	<p style="text-align: center;">⚠ WARNING</p> <p>ALWAYS wear safety glasses when servicing this equipment.</p> <p style="text-align: right;">010GENW1012</p>
	<p style="text-align: center;">⚠ WARNING</p> <p>Any alterations to this equipment will void the warranty and may cause a dangerous situation. NEVER make alterations to the equipment. Make sure all machine switches are in the OFF position before plugging the equipment into the receptacle.</p> <p style="text-align: right;">011GENW1012</p>
	<p style="text-align: center;">⚠ CAUTION</p> <p>Do NOT allow direct contact of this equipment by the public when used in food service locations. Only personnel trained and experienced in the equipment operation may operate this equipment. Carefully read all instructions before operation.</p> <p style="text-align: right;">012GENC1012</p>
	<p style="text-align: center;">⚠ CAUTION</p> <p>This machine is NOT to be operated by minors. Minors are classified as anyone under the age of 18.</p> <p style="text-align: right;">007GENC1012</p>

NOTE: Improvements are always being made to Gold Medal's equipment. This information may not be the latest available for your purposes. It is critical that you call Gold Medal's Technical Service Department at 1-800-543-0862 for any questions about your machine operations, replacement parts, or any service questions.



INSTALLATION INSTRUCTIONS

Inspection of Shipment

Unpack all cartons and check thoroughly for any damage that may have occurred during transit. Damage claims should be filed immediately with the transportation company.

Setup

Your new Hawaii's Finest was completely assembled and tested at the factory. Remove all packing material and tape before starting operation.

Electrical Requirements

The following power supply must be provided:

1027HD: 120V, 1536W, 60 Hz

1027HDX: 230V, 1472W, 50 Hz

	⚠ DANGER
	<p>Machine must be properly grounded to prevent electrical shock to personnel. Failure to do so could result in serious injury, or death.</p> <p>Do NOT immerse any part of this equipment in water.</p> <p>Do NOT use excessive water when cleaning.</p> <p>Keep cord and plug off the ground and away from moisture.</p> <p>Always unplug the equipment before cleaning or servicing.</p>

Your electrician must furnish sufficient power for proper machine operation. We recommend this shaver be on a dedicated and protected circuit. Failure to wire properly will void the warranty and may result in damage to the machine. It is Gold Medal Products Company's recommendation that this machine be plugged directly into a wall outlet. The use of extension cords is not recommended due to safety concerns, and may cause sacrificed and/or reduced performance.

Before You Plug In Machine

1. Make sure the wall outlet can accept the grounded plugs (where applicable) on the power supply cord.
2. The wall outlet must have the proper polarity. If in doubt, have a competent electrician inspect the outlet and correct if necessary.
3. **DO NOT** use a grounded to un-grounded receptacle adapter.
4. Make sure to leave enough room in the back of the machine to allow hookup of the drain hose.



OPERATING INSTRUCTIONS

Ice Requirements

The Hawaii's Finest can take ice cubes or block ice, if you break the block into pieces approximately 2 to 3 inches in size.

NOTE: The ice will not enter the shaving chute if the pieces are too large.

Operation of Hawaii's Finest

1. Allow ice to soften at least 1 hour in an ice cooler before use. Using ice straight from the freezer affects the quality of the shaved ice as well as damage the shaver blade.
2. Lift cover lid and load ice cubes about ½ full then close the lid. Be sure ice is loaded evenly in each cavity. Place cup directly below the ice chute and turn power "ON". Failure to close the lid will cause machine not to operate!
3. Adjust the blade height with the adjustment knob to achieve the preferred ice texture.
4. To stop, turn power switch to the "OFF" position. Should the motor thermal protector trip, reset it by pushing the red button. It is recommended the cause of over load be found and eliminated before continuing. The machine may need to cool a bit before the reset button may take effect.

NOTE: Never allow any foreign or metallic objects around the shaver area of the Hawaii's Finest. Ice picks, scoops, and debris that may be in the ice often damage blades.

Controls and Their Functions

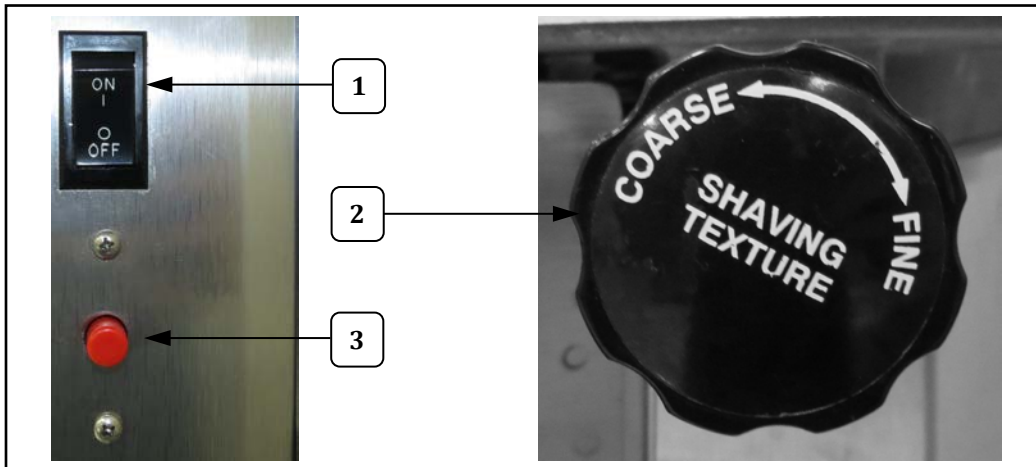

Item	Part Description	Qty.	Part Number	
			1027HD	1027HDX
1	SWITCH, SPST ROCKER	1	12115	
	SWITCH, SPST ROCKER			12115EX
2	KNOB-BLADE ADJUSTMENT	1	12111	12111
3	RESET SWITCH	1	12316	12316



CARE AND CLEANING

Cleaning Instructions

1. Remove lid by removing the wing nut and hinge pin.
2. Remove the four plastic button screws that hold top hopper cover, and lift and roll over.
3. Disconnect wire harness at plug.
4. Remove three thumb screws and remove impeller cover.
5. Remove impeller knob, and lift impeller off. For removal of Impeller Knob a screwdriver slot is supplied on bottom end of motor.
6. Lift off bottom plastic base cover.
7. Remove two stainless steel button screws holding chute.
8. Wipe down all easily accessible areas with a clean, dry cloth.

Blade Cleaning Instructions

1. Blade holder should be cleaned at weekly intervals. Begin removal by removing chute.
2. Using blade adjustment knob, unscrew blade adjustment shaft and remove.
3. Pull pivot pin out completely.
4. Blade, blade holder assembly and spring are now free for removal.
5. Remove the two blade retaining screws and remove blade.
6. Wipe area and parts with clean, dry cloth.
7. Assemble in opposite order as above.

The stainless steel body of the shaver can be kept clean with cleaner designed for stainless steel and a clean cloth. We recommend Gold Medal Products Company's authentic Watchdog Stainless Steel Polish (Part No. 2088.)

NOTE: Never use abrasives on the stainless steel body.

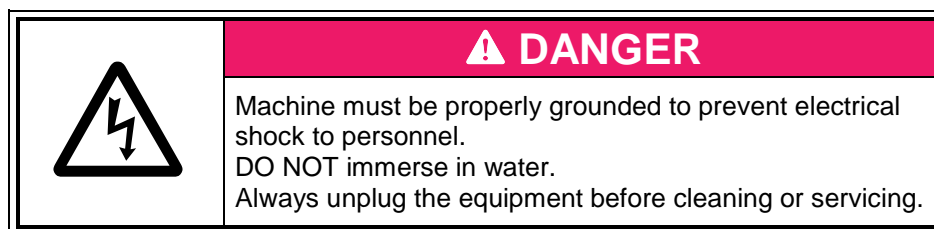

Good sanitation practice demands that all food preparation equipment be cleaned regularly. A clean looking, well-kept machine is one of the best ways of advertising your product.



MAINTENANCE INSTRUCTIONS

	⚠ DANGER
	Do NOT immerse the equipment in water. Unplug your machine before servicing.

	⚠ WARNING
	Adequate eye protection must be used when servicing this equipment to prevent eye injury.

	⚠ CAUTION
	THE FOLLOWING SECTIONS OF THIS MANUAL ARE INTENDED ONLY FOR QUALIFIED SERVICE PERSONNEL WHO ARE FAMILIAR WITH ELECTRICAL EQUIPMENT. THESE ARE NOT INTENDED FOR THE OPERATOR.



ORDERING SPARE PARTS

1. Identify the needed part by checking it against the photos, illustrations, and/or parts list.
2. When ordering, please include part number, part name, and quantity needed.
3. Please include your model number, serial number, and date of manufacture (located on the machine nameplate) with your order.
4. Address all parts orders to:

Parts Department
Gold Medal Products Co.
10700 Medallion Drive
Cincinnati, Ohio 45241-4807

Or, place orders by phone or online:

Phone: (800) 543-0862
(513) 769-7676

Fax: (800) 542-1496
(513) 769-8500

E-mail: info@gmpopcorn.com

Web Page: www.gmpopcorn.com



Cabinet Exterior Assembly

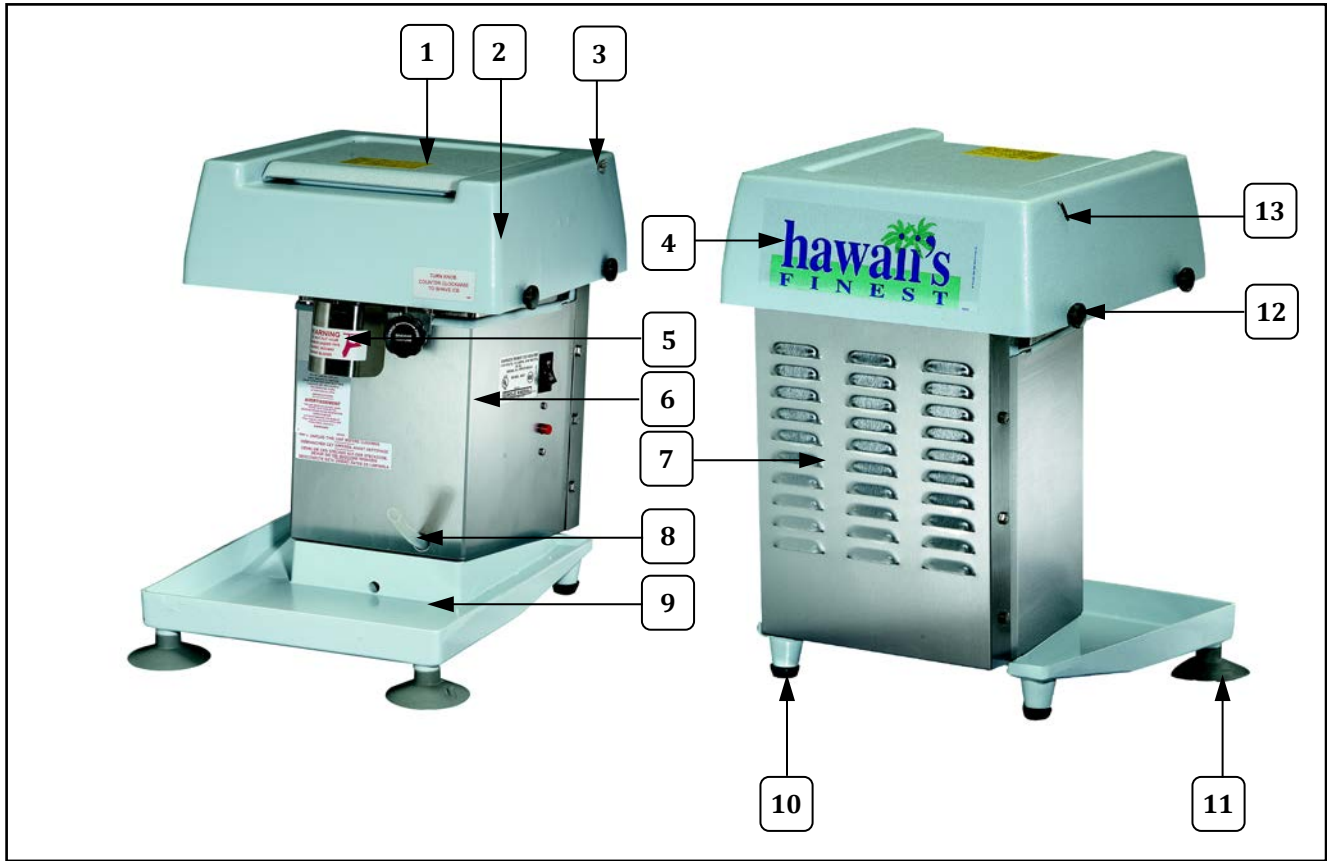

Item	Part Description	Qty.	Part Number	
			1027HD	1027HDX
1	TOP COVER DOOR	1	12119W	12119W
2	TOP COVER	1	12557W	12557W
3	WING NUT 6-32 STL ST	1	12152	12152
4	ICE SHAVER DECAL	2	12155	12155
5	ICE CHUTE WELD ASSEMBLY	1	12683	12683
6	PEDISTAL MAIN WRAPPER	1	12639	12639
7	BACK COVER	1	12638	12638
8	1/2 ID SILCON TUBING	1.3'	12156	12156
9	BASE	1	12088	12088
10	RUBBER BUMPER	2	12487	12487
11	SUCTION CUP, 1/4-20 STUD	2	12642	12642
12	TOP COVER KNOB	4	12112	12112
13	HINGE PIN DOOR	1	12145	12145



Cabinet Exterior Assembly

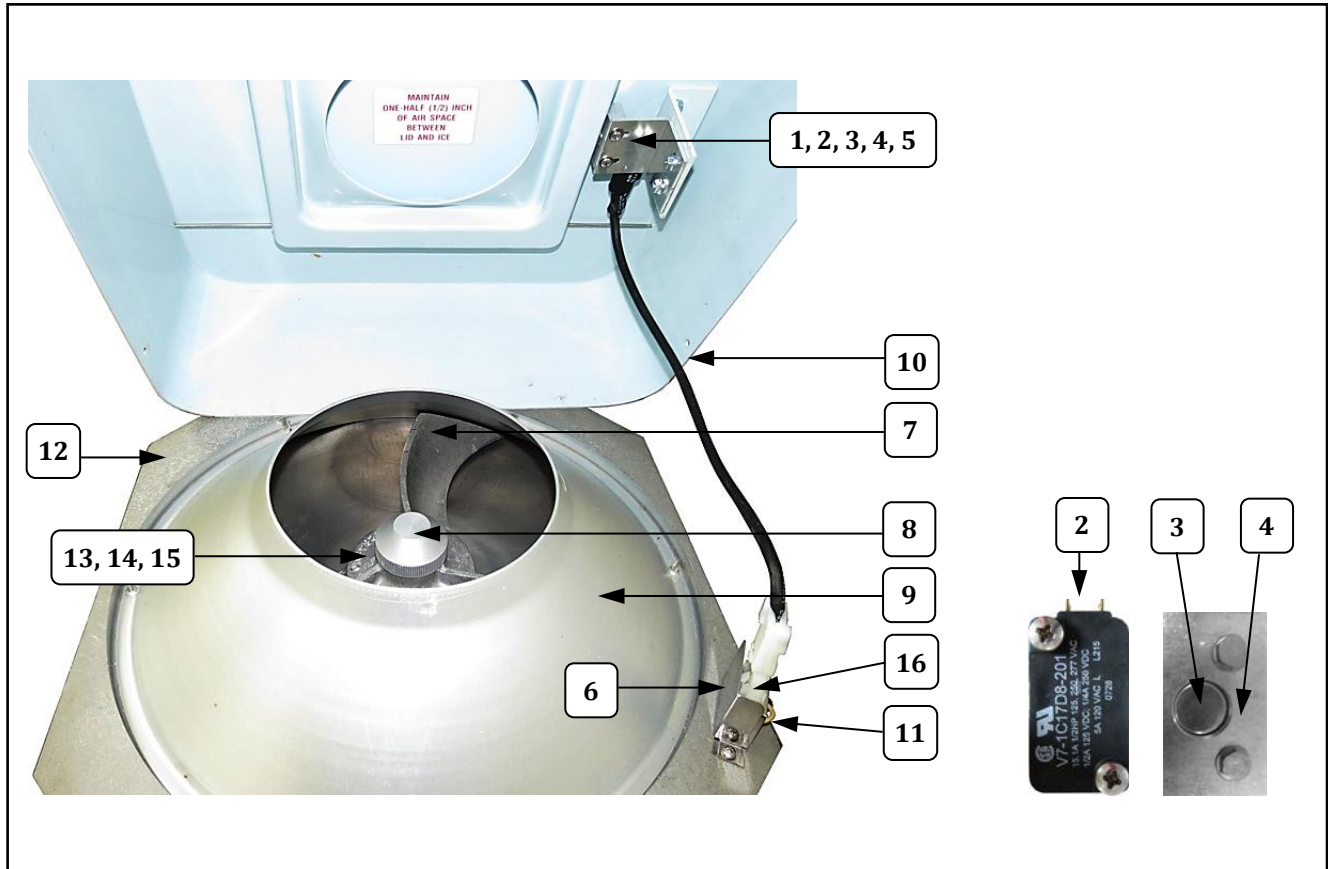

Item	Part Description	Qty.	Part Number	
			1027HD	1027HDX
1	SWITCH MOUNTING BRACKET	1	12136	12136
2	DOOR SAFTEY SWITCH	1	12116	12116
3	1/2 OD X 1/2 T MAGNET	1	12078	12078
4	MOUNTING BLOCK MAGNET	1	12135	12135
5	SPACER (Not Shown)	1	12151	12151
6	WATER SHIELD	1	12097	12097
7	IMPELLER	1	12090	12090
8	IMPELLER NUT	1	12106	12106
9	SPINNING HOPPER	1	12109	12109
10	DOOR SAFTEY SWITCH HARNESS	1	12131	12131
11	WIRING HARNESS BRACKET	1	12146	12146
12	UPPER BASIN	1	12556	12556
13	PUSHER IMPELLER (Not Shown)	1	12098	12098
14	PUSHER STUD (Not Shown)	1	12104	12104
15	BALL BEARING F. 5/8" SHFT (Not Shown)	1	12091	12091
16	WATER SHIELD HARNESS	1	12160	12160



Shaver Assembly

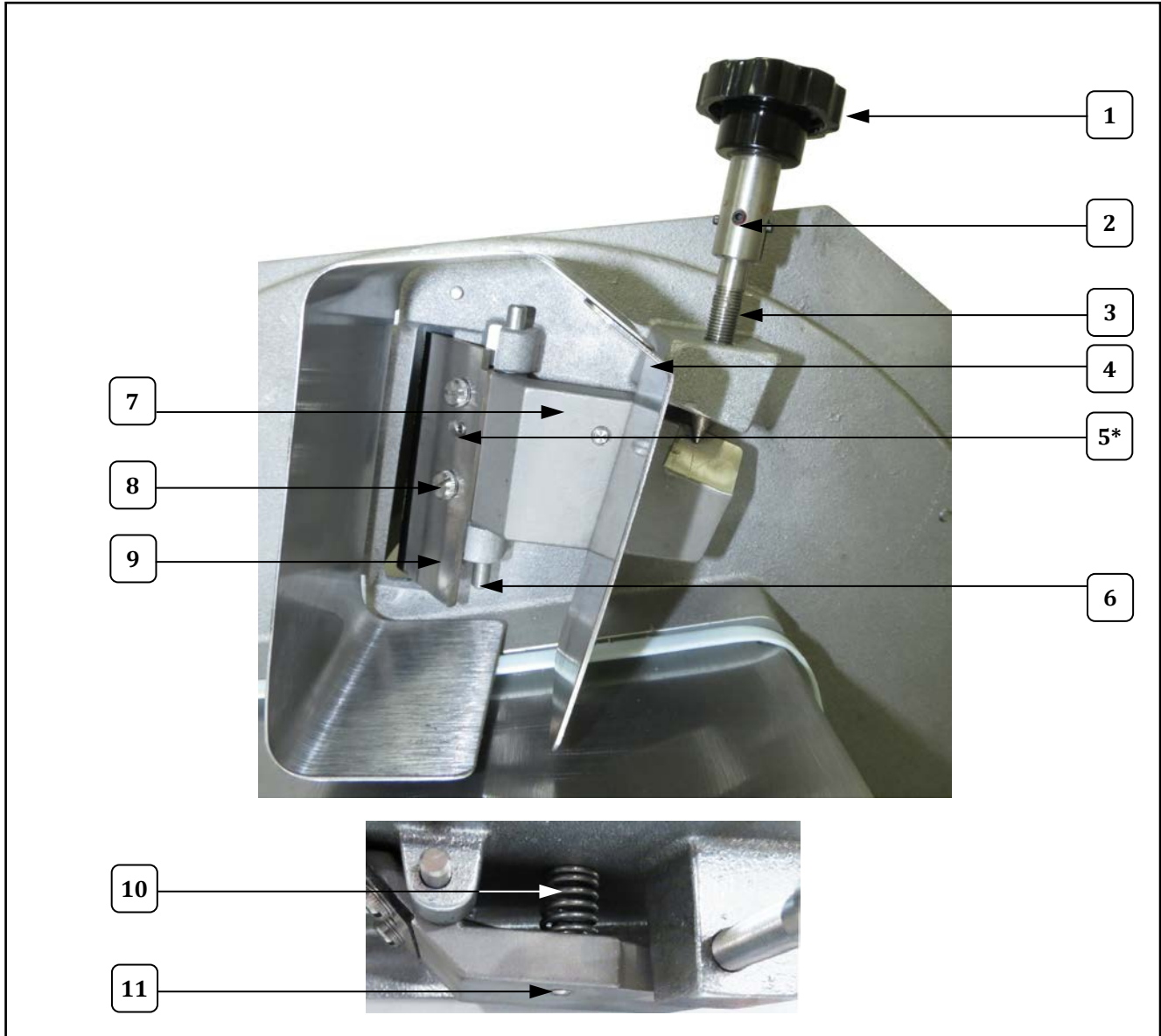

Item	Part Description	Qty.	Part Number	
			1027HD	1027HDX
1	BLADE ADJUSTMENT KNOB	1	12111	12111
2	SET SCREW 8-32 X 1/8 S.S.	1	12165	12165
3	BLADE ADJUSTMENT SCREW ASSEMBLY	1	12125	12125
4	ICE CHUTE WELD ASSY	1	12683	12683
5*	10-32 x 1/2 HOLLOW SET*	1	12129	12129
6	BLADE HOLDER PIN	1	12110	12110
7	BLADE HOLDER	1	12195	12195
8	THUMB SCREW 10-32 X 3/8	2	12158	12158
9	SHAVER BLADE	1	12094	12094
10	COMPRESSION SPRING	1	12117	12117
11	STUD SPRING RETAINER	1	12143	12143

***NOTE:** Factory pre-set, **DO NOT** tamper with



Cabinet Internal Assembly

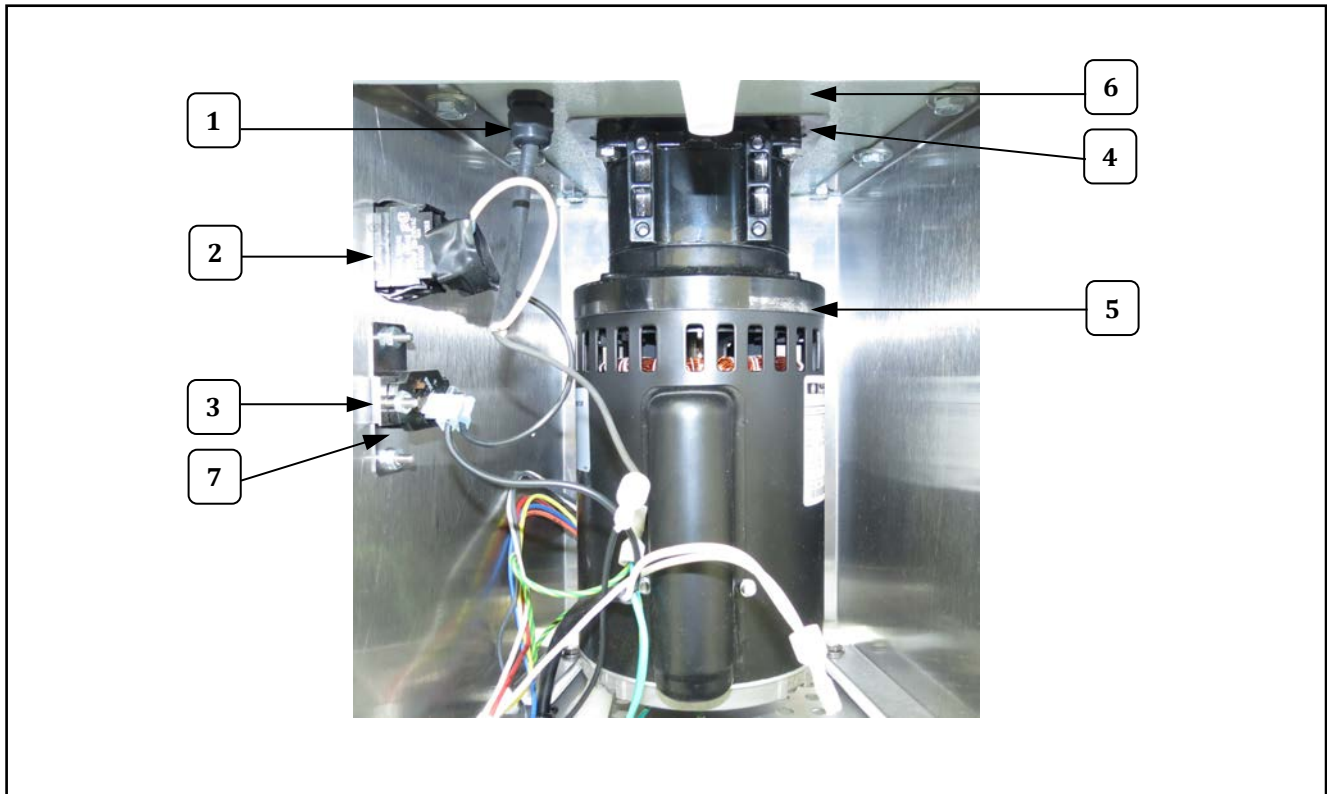

Item	Part Description	Qty.	Part Number	
			1027HD	1027HDX
1	STRAIN RELIEF-WATER TIGHT	1	12149	12149
2	SPST ROCKER SWITCH	1	12115	
	SPST ROCKER SWITCH			12115EX
3	RESET SWITCH	1	12316	12316
4	MOTOR SUPPORT PLATE	1	12514	12514
5	DIRVE MOTOR	1	12261	12261
6	DRAIN TRAY UPPER BASIN	1	12643	12643
7	MOUNT BRACKET-SWITCH	1	12181	12181



Cabinet Bottom Assembly

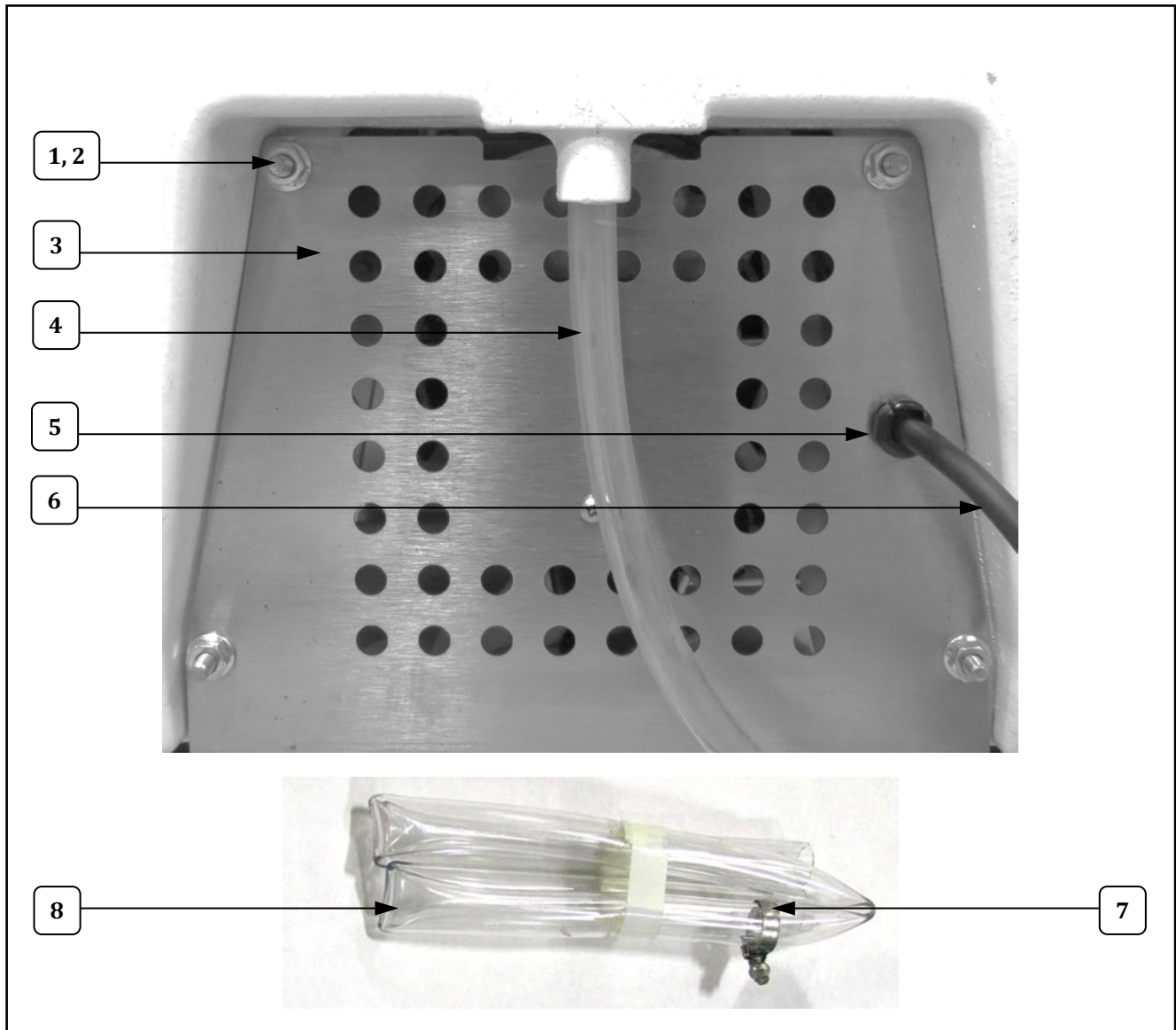

Item	Part Description	Qty.	Part Number	
			1027HD	1027HDX
1	1/4-20 X 1 HX HD C S 18-8	4	12185	12185
2	5/16 FLAT WASHER, 18-8	4	12184	12184
3	BOTTOM COVER STAINLESS	1	12294	12294
4	1/2 ID SILCON TUBING	1.3'	12156	12156
5	STRAIN RELIEF #SR-6P3-4	1	76026	76026
6	LEAD-IN CORD 15 AMP PLUG	1	12154	
	EXPORT POWER SUPPLY CORD			42369
7	HOSE CLAMP WITH SCREW	1	41163	41163
8	DRAIN HOSE 3/4 ID 7/8 OD	4'	12159	12159



Wiring Diagram 1027HD

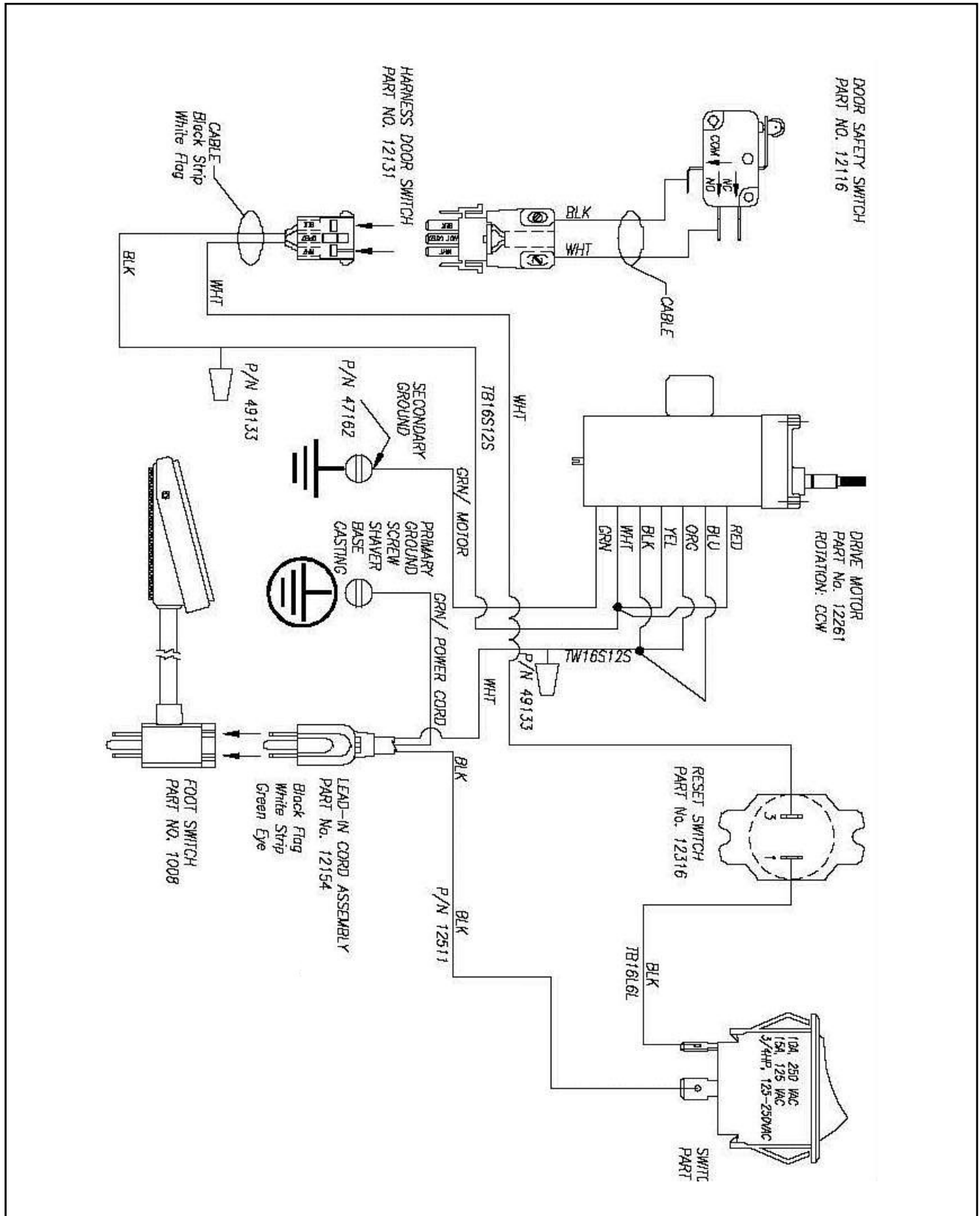



Wiring Diagram 1027HDX

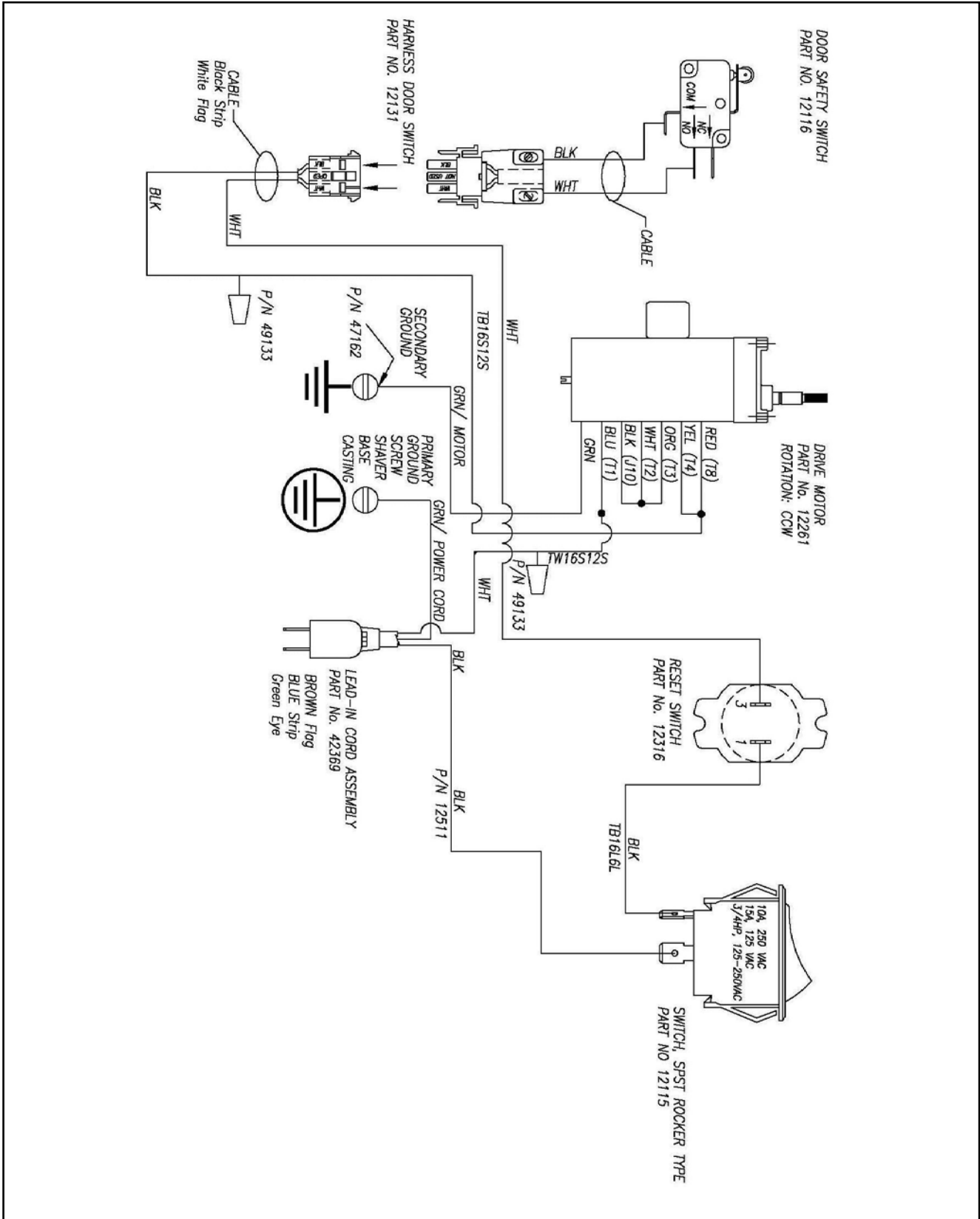



WARRANTY

WE WARRANT to the original purchaser the Gold Medal equipment sold by us to be free from defects in material or workmanship under normal use and service. Our obligation under this warranty shall be limited to the repair or replacement of any defective part for a period of six (6) months from the date of sale to the Original Purchaser with regard to labor and two (2) years with regard to parts and does not cover damage to the equipment caused by accident, alteration, improper use, voltage, abuse, or failure to follow instructions.

THIS WARRANTY IS IN LIEU OF ALL OTHER WARRANTIES EXPRESSED OR IMPLIED, AND OF ALL OTHER OBLIGATIONS OR LIABILITIES ON OUR PART, INCLUDING THE IMPLIED WARRANTY OF MERCHANTABILITY. THERE ARE NO WARRANTIES WHICH EXTEND BEYOND THE DESCRIPTION ON THE FACE HEREOF. We neither assume, nor authorize any other person to assume for us, any other obligation or liability in connection with the sale of said GOLD MEDAL equipment or any part thereof.

The term "Original Purchaser" as used in this warranty shall be deemed to mean that person, firm, association, or corporation who was billed by the GOLD MEDAL PRODUCTS COMPANY, or their authorized distributor for the equipment.

THIS WARRANTY HAS NO EFFECT AND IS VOID UNLESS THE ORIGINAL PURCHASER FIRST CALLS GOLD MEDAL PRODUCTS COMPANY AT 1-800-543-0862 TO DISCUSS WITH OUR SERVICE REPRESENTATIVE THE EQUIPMENT PROBLEM, AND, IF NECESSARY, FOR INSTRUCTIONS CONCERNING THE REPAIR OR REPLACEMENT OF PARTS.

NOTE: This equipment is manufactured and sold for commercial use only.



GOLD MEDAL® PRODUCTS CO.

10700 Medallion Drive, Cincinnati, Ohio 45241-4807 USA

www.gmpopcorn.com

Phone: (800) 543-0862

(513) 769-7676

Fax: (800) 542-1496

(513) 769-8500