



SALAD / SANDWICH PREP TABLES



› FEATURES

- CFC free refrigerant and foam insulation
- Electronic thermostat and digital LED temperature display for accurate control and easy reading
- Easy to mount 2.5" casters (two lockable in front) are standard with all units
- Self-closing doors that remain open at 90 degrees
- Magnetic gasket can be replaced without any tools
- Adjustable, heavy-duty epoxy coated wire shelves (one per door)
- Stainless steel framework construction
- Auto defrosting and auto evaporation of condensation water
- 1/6 x 4" PC pans & 11.4" PE cutting board included
- * Unit can be custom-ordered with 6" PC pans
- Exterior: 430 stainless steel top, front & sides. Aluminum back panel & galvanized bottom
- Interior: 304 stainless steel floor, ABS sides & door backs. Aluminum back panel
- Temperature: 33 to 41°F / 0.5 to 5°C
- Electrical: 115/60/1 with NEMA 5-15P plug

› SPECIFICATIONS

MODEL	DOORS	EXT. DIMENSIONS W x D x H (in)	INT. DIMENSIONS W x D x H (in)	AMPS	H.P.	SHIP WEIGHT
KSP29	1	28.9 x 29.9 x 43.2	25.6 x 25.6 x 24.5	5	3/8	225 lbs
KSP48	2	48.2 x 29.9 x 43.2	43.5 x 25.6 x 24.2	7	1/2	322 lbs
KSP60	2	61.2 x 29.9 x 43.2	56.5 x 25.6 x 24.2	7.5	1/2	373 lbs
KSP72	3	71.7 x 29.9 x 43.2	67.0 x 25.6 x 24.2	7.5	1/2	408 lbs

› OPTIONS - DRAWERS *

KSP29-2D • KSP48-2D • KSP48-4D • KSP60-2D • KSP60-4D

See page 34 for pan configurations for units with drawers.

*Available by custom order only. Please contact our Sales Department for availability and lead time.

CERTIFIED TO ANSI/NSF-7 STANDARDS



Head Office : 5659 Royalmount Ave., Montreal, Qc, Canada H4P 2P9
TEL: (514) 737-9701 • TOLL FREE: (888) 275-4538
FAX: (514) 342-3854 • TOLL FREE FAX: (877) 453-8832

US Sales Office : 12000 Biscayne Blvd, Suite 108, Miami, FL 33181
TEL: (786) 600-4687 • TOLL FREE: (844) 218-8477 • FAX: (786) 661-4100
mvpgroupcorp.com • sales@mvpgroupcorp.com



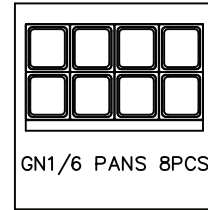
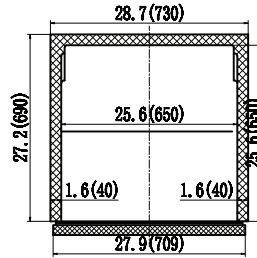
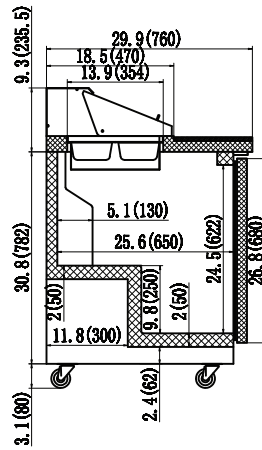
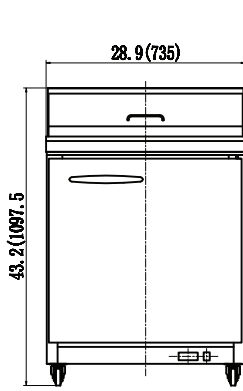

GN1/6 PANS 8PCS

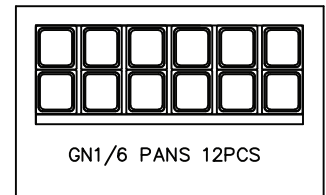
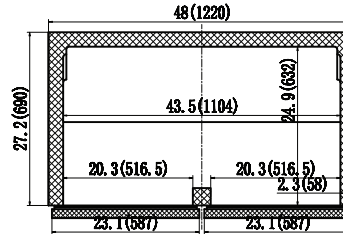
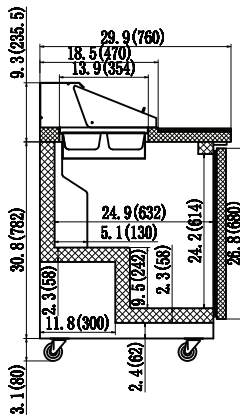
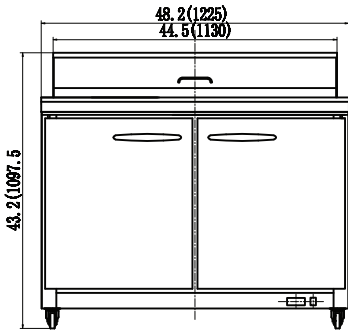

GN1/6 PANS 12PCS

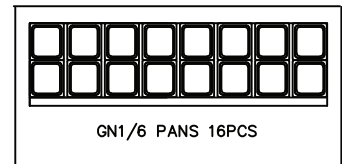
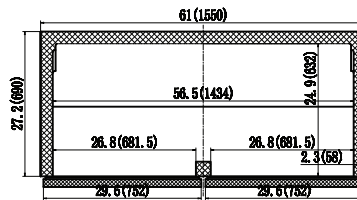
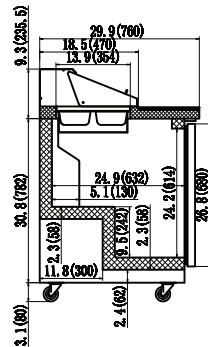
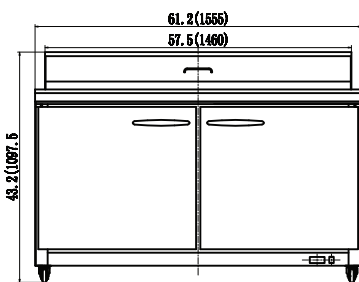

GN1/6 PANS 16PCS

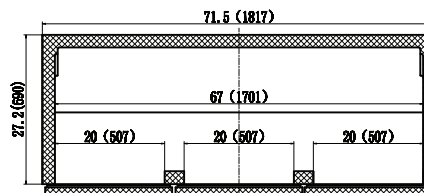
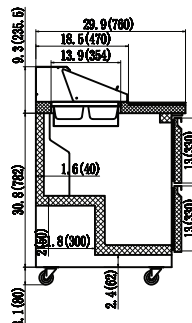
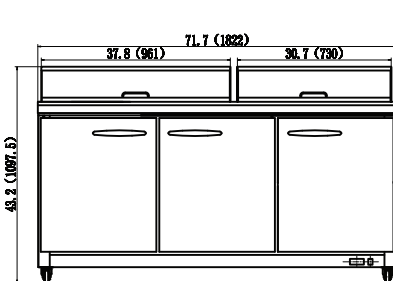

GN1/6 PANS 18PCS

Dimensions in inches (mm)