

Job: _____

Item No: _____

CA61-PF30-SD-R

Economy Proofer - Non Insulated

Features:

- Digital thermometer
- Temperature adjustable to approximately 160° F
- Exterior mounted controls
- Easy to use heat unit with separate temperature and humidity controls
- Removable heat unit for easy maintenance and repair
- Blower fan and pan stop provide uniform heat distribution throughout cabinet
- 18" x 26" pans are lip-hung on 1 1/2" centers
- Standard with right hand hinging; left hand hinging available upon request

Options:

- Clear door
- Perimeter or corner bumpers
- Hasp lock
- Caster options available



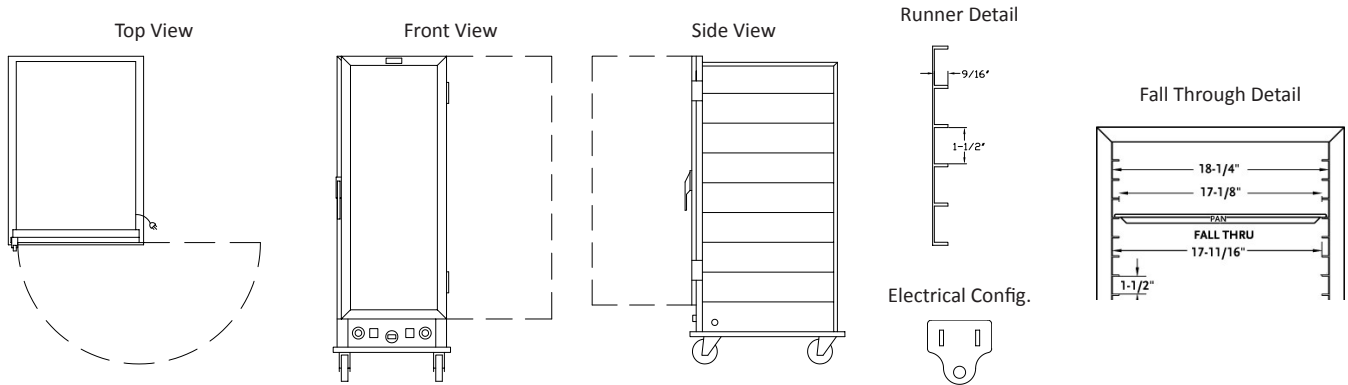

Lockwood Model No.	Pan			Exterior Dimensions			Inside Dimensions				Weight
	Angles	Capacity		Width	Depth	Height	Width	Depth	Height		
CA61-PF30-SD-R	Extruded Sides	30	IN	22 3/8	31 3/16	62 7/8	18 1/4	26 3/4	48 3/8	LBS	105
			CM	56.85	79.22	159.72	46.36	67.95	122.89	KG	47.63

** Add 2" to width and depth with corner bumper option

Cabinet Specifications:

- Top & back panel: One piece 0.125" aluminum welded to extruded side panels and base
- Side panels: Extruded .070" aluminum panels; welded together.

Base Specifications:

- One piece .125" aluminum; formed construction
- Casters: (4) 5" x 1 1/4" High Tech grey swivel (2 w/brakes); load capacity 250 lbs each (113.4 kg); temp. range -45 ° / +180° F

Door Specifications:

- Frame: 7/8" x 1 3/4" extruded aluminum screwed and welded together
- Panel: .63" aluminum sheet, fitted into door frame
- Latch: Magnetic type latch handle screwed to door frame
- Hinges: 4" stainless steel - opens 180°
- Gasket: Perimeter; fitted into frame extrusion, flexible PVC rubber

Pan Support Specifications:

- Extruded .070" aluminum

Heat Unit Specifications:

- Removable bottom mount proof / hold unit
- Body: Formed .063" aluminum
- Thermostat (holding): Mechanical, up to 195°
- Thermostat (humidity): Mechanical, up to 95%
- Indicator lights: Power, Proof, Hold modes
- Switches: (2) Rocker type with guards
- Heat Elements: (1) 1000 W, (1) 500 W internal; (1) 1000 W immersible external for proofing
- Blower Motor
- Thermometer
- Water Pan: 4.3 quart, 23 ga., 18/8 stainless steel

Power Requirements:

- 1500 Watts, 120 Volts, 60 Hz, Single Phase 15 Amp.
- Dedicated 15 Amp. service.

Lockwood reserves the right to change materials and specifications without notice.